

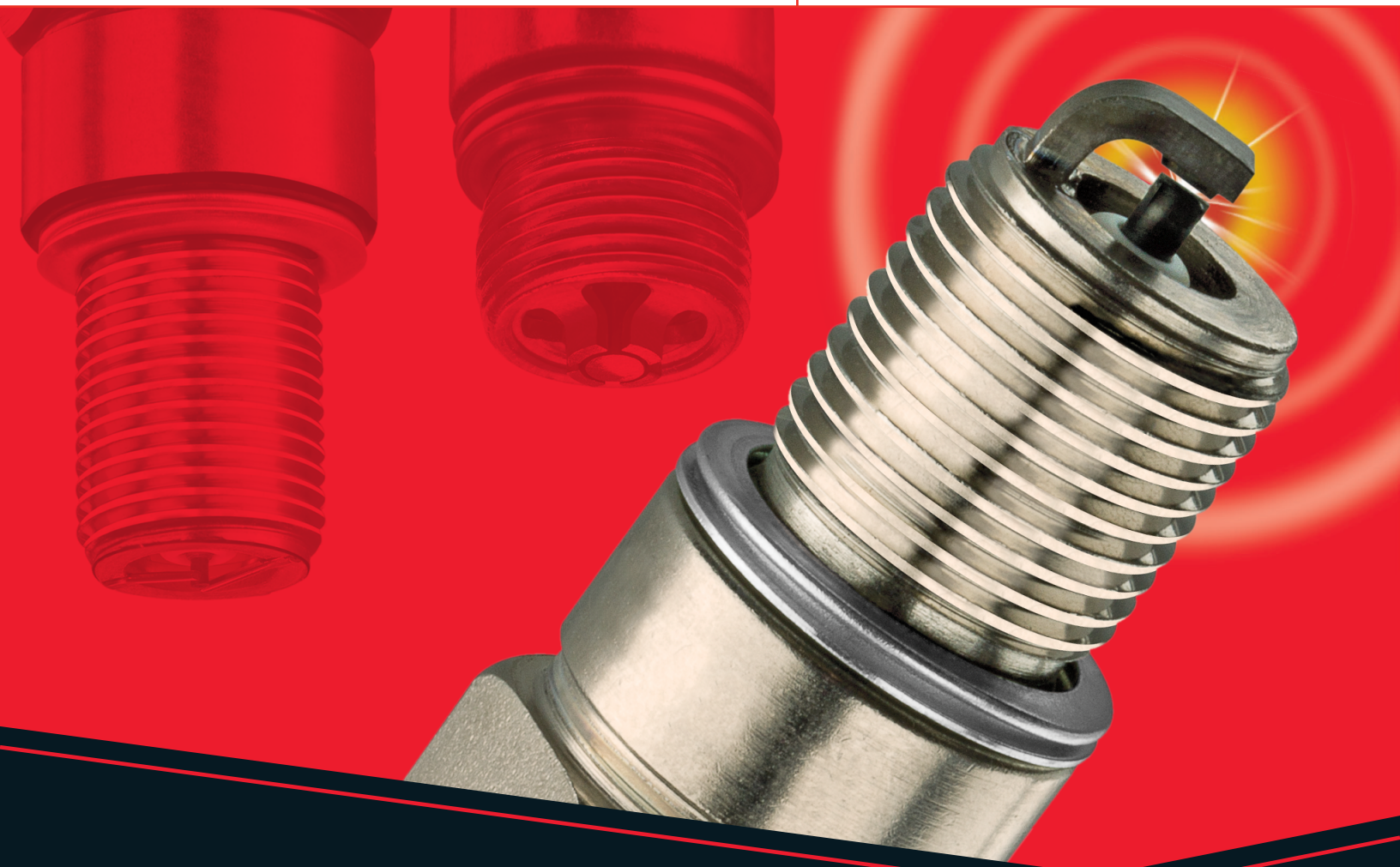

2012

Industrial Spark Plug
Application Catalog



**PERFORMANCE
DRIVEN™**

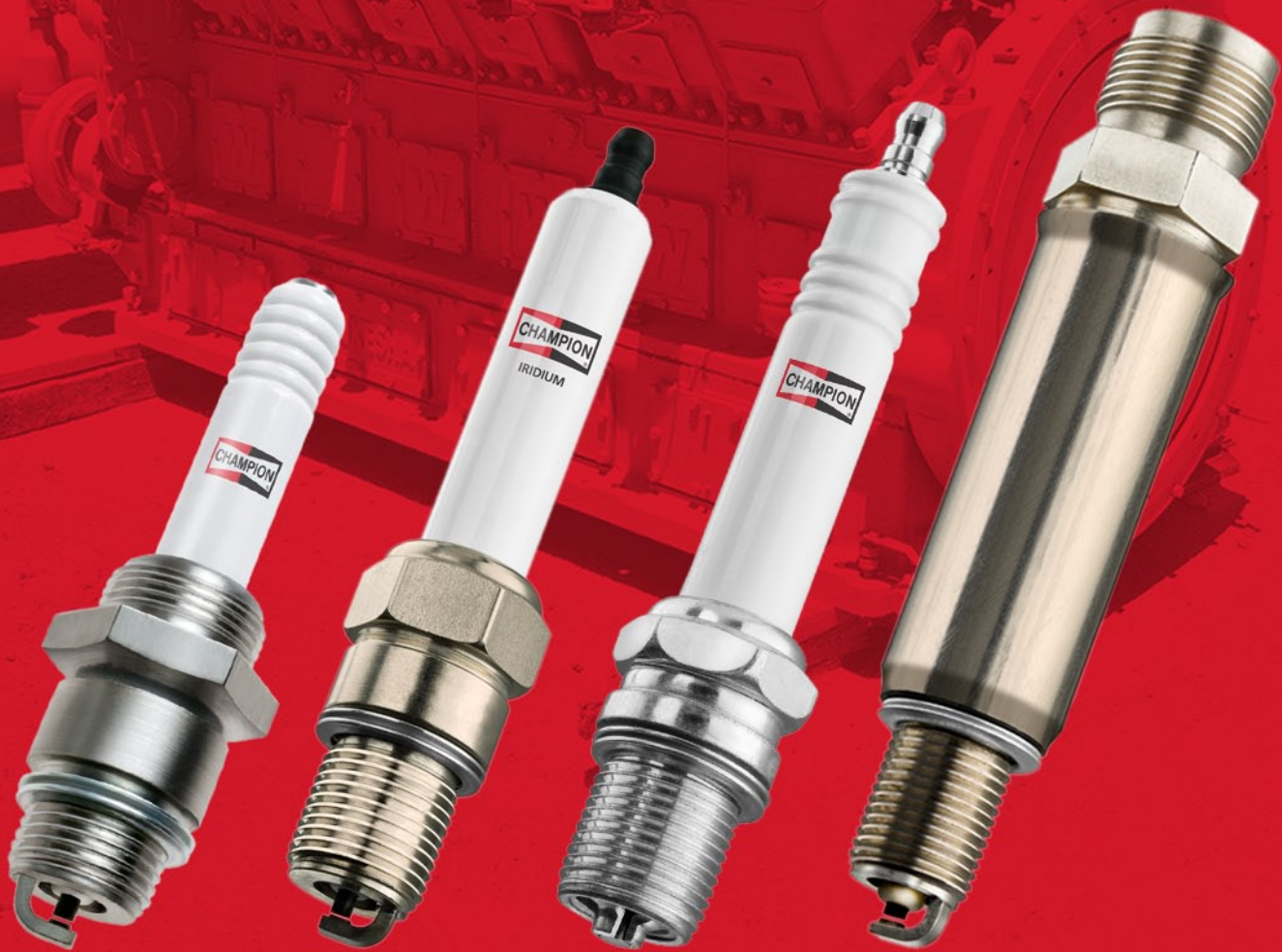

Industrial Power



GENERAL INFORMATION

B Series Plugs II
M Series Plugs IV
N Series Plugs VI
C Series Plugs VIII
Plug Type X

INDUSTRIAL APPLICATIONS

Commercial, Stationary and Gas Engine Applications 1
Commercial, Stationary and Gas Engine Applications - 5/8" - 24 Shielded 24

INDUSTRIAL TECHNICAL INFORMATION

Industrial Spark Plug Gaps 27
Heat Range Chart 29
Replacements For Discontinued Spark Plugs 30
Cross Reference Chart 32
Military Shielded Resistor Types 34
Spark Plug Installation 35
Corona vs. Flashover 36
Connector Well Flashover / Contamination 36
The Spark Plug's Relation To The Ignition System 37
Factors Affecting Voltage Requirements 37
Factors Affecting Spark Plug Temperatures 38
Heat Range Facts 39
Effect Of Fuel On Spark Plug Selection 40
Shielded Extensions, non-Shielded Extensions, Gaskets and Terminal Nut 40
Integral Coil Features 41
Shielded Extensions Features and Installation 41
Spark Plug Analysis 42



18mm



13/16"



7/8"



Solutions Driven by Performance.

B-Series Category Overview	
Champion® Iridium	FB77WPCC
	KB77WPCC
	RB77WPCC
	RB77WPC
Champion Platinum	RB75PP
	RB76PP
Champion Integral Coil	RTB77WPCC
Champion Copper	RB77CC
	RB77N
	RB75N
	KB75N
	RB76N

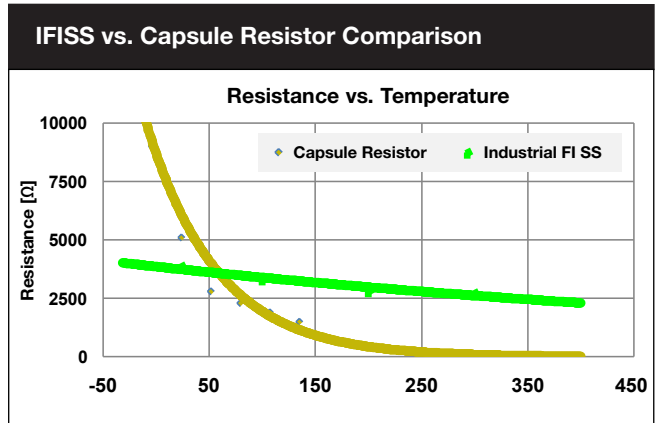

IFISS offers tight resistance control across the entire temperature operating window, magnitudes improvement vs. capsule resistor

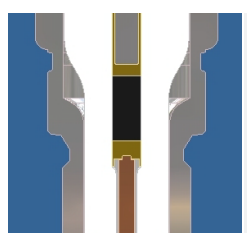

Specifically designed for industrial applications, IFISS is a fired in suppressor seal, which significantly improves both resistance and suppression capability over the life of the plug.

Pictured Plug:
FB77WPCC

High-alumina content insulator with stronger, highly damage-resistant cross-section ensures superior durability.

IFISS technology engineered specifically for demanding, high-temperature/high-load applications requiring consistent resistance throughout the plug's service life.

Hot-Lock Nickel Plated Shell Seal dramatically increases strength, rigidity and resistance to lift.

WPCC	PP	CC	N
 <p>Champion® Iridium spark surface for improved resistance to wear. Advanced rectangular bar design provides improved ignitability and longer life.</p>			



18mm



1/2"



7/8"



Full Product Offerings of ATEX-CSA Certified Spark Plugs.

M-Series Category Overview	
Champion® Iridium	RM82WPCC
Champion Platinum	RM77PP
Champion Shielded	RHM78WPCC RHM78PP RHM83N RHM77N RHM78N REM84P REM77N
Champion Integral Coil	RTM82WPCC RTM77PP RTM79N RTM77N RTM78N RGM86N
Champion Copper	RM77N RM85G

Advanced Laser Welding Process



Super Modulated Continuous Wave (SMCW) Laser Benefits

- Consistent/uniform weld penetration and coverage
- Improved bi-metal alloying through improved heat/energy control
- Multi-configuration compatible (precious metal)
- Fully automated
- Weld parameter/input flexibility

Pictured Plugs:
RM77N (Left)
RTM82WPCC (Right)

High-alumina content insulator with stronger, highly damage-resistant cross-section ensures superior durability.

M-Series also offers many Integral Coil and Shielded plug designs for all applications.

ATEX-CSA
Certified Plug

N



Massive surface area with the four ground electrode firing end to extend the life of the plug.

WPCC



Super modulated continuous wave laser welding of platinum ground electrode creates high-strength bond with base material.

G



PP





14mm



3/4"



13/16"



Powered by Double Fine Wire Technology.

N-Series Category Overview	
Champion Platinum	RN79PYP
Champion Gold/Palladium	RN79G
Champion Shielded	RHN79G
Champion Integral Coil	RTN79G

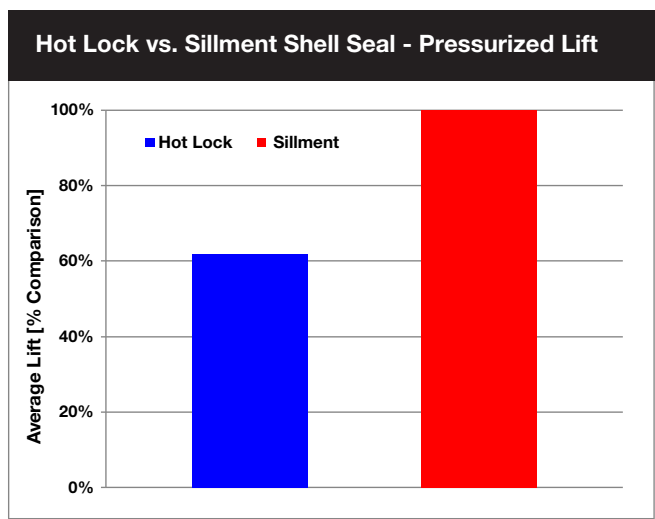

- At 55MPa applied pressure, the new hot-lock design shows a 40% reduction in core lift due to increased shell rigidity and pre-assembled load.
- Increased rigidity and pre-assembled load also provides a more consistent, evenly distributed, and higher compression load at the lower shell seat, resulting in improved sealing against combustion gases.

Pictured Plug:
RN79G

Sure-Fire advanced ceramic body.



Hot-Lock Nickel Plated Shell Seal dramatically increases strength, rigidity and resistance to lift.

G

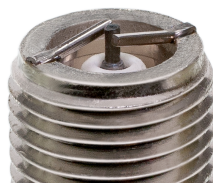

Gold/Palladium fine wire technology that extends the life of the plug through heat transfer and ignitability.

PYP





14mm



3/4"



5/8"



Full Product Offerings for Transit Solutions.

C-Series Category Overview	
Champion® Iridium	RC78WYP RC78WP
Champion Platinum	RC78PYP
Champion Shielded	EP3RCWYP15-1 EP8RCWYP15-2
Champion Copper	RC78YCC

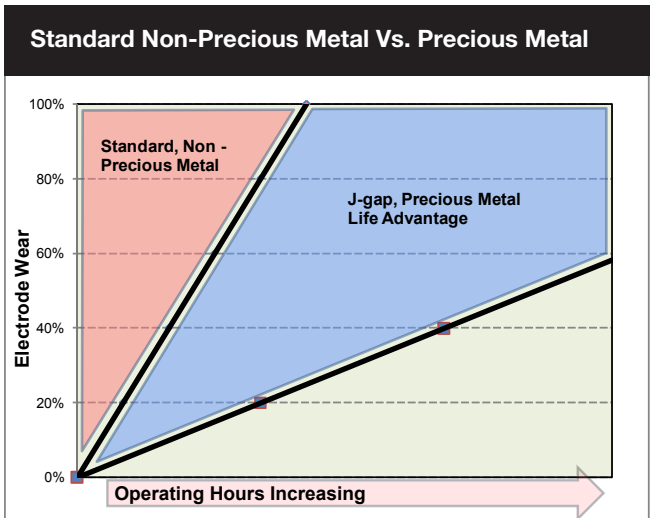

Non-Precious Metal vs. Precious Metal spark plug has a direct effect on the life and maintenance schedule of your engine. Precious Metal plugs provide significantly longer required life between service intervals improving efficiency by reducing the amount of plug service stops to maintain the engine.

Pictured Plug:
RC78WYP

Sure-Fire™ advanced ceramic body.



Hot-Lock Nickel Plated Shell Seal dramatically increases strength, rigidity and resistance to lift.

WYP



Massive Champion® Iridium center electrode and Platinum ground electrode design provides longer life.

PYP



YCC





SUPPRESSOR / SHIELDING	
Letter	Description
E	Shielded 5/8"-24
F	Industrial Resistor
H	Shielded 3/4"-20
K	Resistor (Special Application)
M	Shielded 5/8"-24 Ordnance
R	Resistor
T	13/16"-20 Thread Above Hexagon
U	Auxiliary Gap
X	Resistor (Special Application)

SHELL DESIGN			
Letter	Thread Size	Reach	Hex
B	18mm	13/16"	7/8"
C	14mm	3/4"	5/8"
D	18mm	1/2"	7/8"
GC*	7/8"-18	All	7/8"
GM*	18mm	All	7/8"
H	14mm	7/16"	13/16"
J	14mm	3/8"	13/16"
L	14mm	1/2" or .472"	13/16"
M	18mm	1/2"	7/8"
N	14mm	3/4"	13/16"
S	1-1/8"	5/8"	1"
W	7/8"-18	All	15/16" or 1"
X	14mm	1/2" or .500"	5/8"

HEAT RANGE / APPLICATION	
Ref. #	Description
1-25	Automotive, Small Engine & Ordnance
75-99	Industrial & Special Applications

FIRING END DESIGN	
Letter	Description
B	Two Ground Electrodes
C	Copper Plus Design
D	Protruding Nose, Round Ground Electrode
F	Three Ground Electrode
G	Fine Wire -- Semi-Precious Electrode
J	Cutback Ground Electrode, Includes Modified Gap
N	Four Ground Electrode
P	Platinum Electrode
R	Push Wire
Y	Standard Projected Core Nose
*PP	Double Platinum
*PYP	Projected Double Platinum
*WP	Iridium/Platinum
WPC	Iridium/Platinum/Copper
WPCC	Iridium/Platinum/Double Copper

SPECIAL GAP DESIGNATION	
No.	Description
15	Gapped at .015"
17	Gapped at .017"
21	Gapped at .021"
25	Gapped at .025"

* 1"-20 Female Connector

The plug type on a spark plug is composed of a basic "Heat Range" number with letters and numbers to indicate major features of the plug design. These charts contain a detailed example of the Champion Sales Symbol.

* Includes Copper Plus Design

ANTIPARASITE / BLINDAGE	
Lettre	Description
E	Électrode protégée 5/8 po-24
F	Résistance Industrielle
H	Électrode protégée 3/4 po-20
K	Résistance (application spéciale)
M	Électrode protégée 5/8 po-24 Matériel militaire
R	Résistance
T	Hexagone à filetage supérieur 13/16 po-20
U	Écartement auxiliaire
X	Résistance (application spéciale)

MODÈLE DE CULOT			
Lettre	Calibre de filetage	Portée	Hexagone
B	18mm	13/16 po	7/8 po
C	14mm	3/4 po	5/8 po
D	18mm	1/2 po	7/8 po
GC*	7/8 po-18	Toutes	7/8 po
GM*	18mm	Toutes	7/8 po
H	14mm	7/16 po	13/16 po
J	14mm	3/8 po	13/16 po
L	14mm	1/2 po ou 0,472 po	13/16 po
M	18mm	1/2 po	7/8 po
N	14mm	3/4 po	13/16 po
S	1-1/8 po	5/8 po	1 po
W	7/8 po-18	Toutes	15/16 po ou 1 po
X	14mm	1/2 po ou 0,500 po	5/8 po

* Raccord femelle 1 po - 20

Le symbole de vente figurant sur une bougie se compose d'un numéro de "gamme thermique" de base ainsi que de lettres et de chiffres indiquant les caractéristiques principales du modèle de bougie. Les tableaux ci-dessus donnent un exemple détaillé d'un symbole de vente Champion.

GAMME THERMIQUE / APPLICATION	
Ref. #	Description
1-25	Automobiles, petits moteurs, matériel militaire
75-99	Applications industrielles et spéciales

ALLUMAGE ET CONCEPT	
Lettre	Description
B	Deux électrodes de masse
C	Concept Copper Plus
D	Pointe saillante, électrode de masse ronde
F	Trois électrodes de masse
G	Fil fin -- électrode en pierre semi-précieuse
J	Électrode de masse raccourcie avec écartement modifié
N	Quatre électrodes de masse
P	Électrode en platine
R	Fil de poussé
Y	Pointe en saillie ordinaire
*PP	Double platine
*PYP	Pointe en saillie double platine
*WP	Iridium/ platine
WPC	Iridium/ platine/ cuivre
WPCC	Iridium/ platine/ double cuivre

* Avec concept Copper Plus

DÉSIGNATION D'ÉCARTEMENT SPÉCIAL	
N°	Description
15	Écartement de 0,015 po
17	Écartement de 0,017 po
21	Écartement de 0,021 po
25	Écartement de 0,025 po

SUPRESOR / PROTECCIÓN	
Letra	Descripción
E	Blindado 5/8" - 24
F	Resistor Industrial
H	Blindado 3/4" - 20
K	Resistor (aplicación especial)
M	Blindado 5/8" - 24 armamento
R	Resistor
T	Rosca por encima del hexágono 13/16" - 20
U	Separación entre puntas auxiliar
X	Resistor (aplicación especial)

DISEÑO DEL RECUBRIMIENTO			
Letra	Tamaño de rosca	Distancia	Hex.
B	18mm	13/16"	7/8"
C	14mm	3/4"	5/8"
D	18mm	1/2"	7/8"
GC*	7/8" - 18	Todas	7/8"
GM*	18mm	Todas	7/8"
H	14mm	7/16"	13/16"
J	14mm	3/8"	13/16"
L	14mm	1/2" ó 0,472"	13/16"
M	18mm	1/2"	7/8"
N	14mm	3/4"	13/16"
S	1-1/8"	5/8"	1"
W	7/8" - 18"	Todas	15/16" ó 1"
X	14mm	1/2" ó 0,500"	5/8"

* Conector hembra 1" - 20

El símbolo de ventas de una bujía está compuesto por un número básico de "gama térmica" con letras y números para indicar las propiedades importantes del diseño de la bujía. Estas tablas contienen un ejemplo detallado del símbolo de ventas de Champion.

GAMA TÉRMICA / APLICACIONES	
No. ref.	Descripción
1-25	Automotriz, motores pequeños, armamento
75-99	Aplicaciones industriales y especiales

DISEÑO DE EXTREMO DE ENCENDIDO	
Letra	Descripción
B	Electrodo de dos tierras
C	Diseño Copper Plus
D	Electrodo redondo a tierra de punta saliente
F	Electrodo de tres tierras
G	Electrodo de alambre fino semiprecioso
J	Electrodo de tierra recortado, incluye separación modificada
N	Electrodo de cuatro tierras
P	Electrodo de platino
R	Alambre de empuje
Y	Punta de núcleo saliente normal
*PP	Platino doble
*PYP	Platino doble saliente
*WP	Iridio/ Platino
WPC	Iridio/ Platino/ Cobre
WPCC	Iridio/ Platino/ Cobre doble

* Incluye diseño Copper Plus

DISEÑO ESPECIAL DE SEPARACIÓN ENTRE PUNTAS	
No.	Descripción
15	Separados 0,015"
17	Separados 0,017"
21	Separados 0,021"
25	Separados 0,025"



COMMERCIAL, STATIONARY AND GAS ENGINE APPLICATIONS

MAKE YEAR and MODEL	PREMIUM LONG LIFE			COPPER PLUS UNSHIELDED			PREMIUM SHIELDED 3/4"-20		SHIELDED 3/4"-20		INTEGRAL COIL TYPE 13/16"-20		
	STOCK NO.	PLUG TYPE	GAP	STOCK NO.	PLUG TYPE	GAP	STOCK NO.	PLUG TYPE	STOCK NO.	PLUG TYPE	STOCK NO.	PLUG TYPE	GAP
ABC													
Washing Machines													
All Models ABC				569	W14	.025							
AJAX													
(Cooper Energy Services)													
6-1/2x8CMA, EA30				589	W89D	.030							
7-1/4x8CMA, E30, 7-1/2x10CMA, E42				589	W89D	.030							
CMA, C30, 7-1/2x10, CMA, EA22 6-1/2x8				569	W14	.030							
DP115, DP125 13-1/4x16				518	W18	.030							
DP160, DPC160 11x14				518	W18	.030							
DP165, DP300, DP325 15x16				518	W18	.030							
DP230, DP250 13-1/4x16				518	W18	.030							
DP60, DPC60, DPC120 9-1/2x12				518	W18	.030							
DP80, DPC80 11x14				518	W18	.030							
DPC115, DPC140 13-1/4x16				518	W18	.030							
DPC162, DPC180, DPC300 15x16				518	W18	.030							
DPC180LE, DPC360LE Main Chamber				518	W18	.030							
DPC180LE, DPC360LE Pre Chamber	1207	RW80PP	.015	510	W10	.015	1204	RHW80PP	532	RHW80N	638	RTW80N	.015
	582	RW82P		545	W85N								
DPC230, DPC280 13-1/4x16				518	W18	.030							
DPC360, DPC540 15x16				518	W18	.030							
DPC600, DPC800				518	W18	.030							
DPC600LE, DPC800LE Main Chamber				518	W18	.030							
DPC600LE, DPC800LE Pre Chamber	1207	RW80PP	.015	510	W10	.015	1204	RHW80PP	532	RHW80N	638	RTW80N	.015
	582	RW82P		545	W85N								
DPC81 10-1/2x12, DPC105 12x14				518	W18	.030							
E15 5-1/4x8, E42, C40, C42 8-1/2x10				569	W14	.030							
WL, EA15 5x6-1/2				569	W14	.030							
ALLIS-CHALMERS													
GASOLINE													
G-138, G-149, G-160, 14 Power Units				871	RJ8C	.025							
				841	J8C								
G-226 3/8" Reach				102	RJ6C	.020							
				871	RJ8C								
G-226, G-262 3/4" Reach				123	RN5C	.025	575	RHN79G			1232	RTN79WYP	.025
				120	N5C						540	RTN79G	
P-1879, PC-1879, PC-2505, PCS-2505				509	D9	.025							
LOW GRADE FUEL													
G-226 3/4" Reach				405	RN14YC	.030							
G-226, W-201 3/8" Reach				592	RJ12C	.030							
				511	J11C								
NATURAL & LP GAS													
G-138, G-149, 14 Power Units				102	RJ6C	.020							
				823	J6C								
G-160				825	J4C	.020							
G-226 3/8" Reach				102	RJ6C	.020							
				871	RJ8C								
G-226, G-262 3/4" Reach				818	RN2C	.025	575	RHN79G			1232	RTN79WYP	.025
				805	N2C						540	RTN79G	
AMERICAN MOTORS													
232, 258 cid 6-Cyl.				404	RN12YC	.025							
				38	N12YC								
304, 360 cid V-8				404	RN12YC	.025							
				38	N12YC								
ARIEL													
JGS-1 High Tension	530	RN79G	.012								1232	RTN79WYP	.012
											540	RTN79G	
JGS-1 Low Tension	530	RN79G									1232	RTN79WYP	.012
											540	RTN79G	
ARROW													
C46, C66, C96, C106, C255				502	D21	.025							
				543	D89D								
C96, C106, C255				502	D21	.025							



MAKE YEAR and MODEL	PREMIUM LONG LIFE			COPPER PLUS UNSHIELDED			PREMIUM SHIELDED 3/4"-20		SHIELDED 3/4"-20		INTEGRAL COIL TYPE 13/16"-20		
	STOCK NO.	PLUG TYPE	GAP	STOCK NO.	PLUG TYPE	GAP	STOCK NO.	PLUG TYPE	STOCK NO.	PLUG TYPE	STOCK NO.	PLUG TYPE	GAP
ARROW													
L-333, L-795, L-1770, L-2165, F-208 VRG220, VRG330	530	RN79G	.015	589 123 120	W89D RN5C N5C	.025 .025	575	RHN79G			1232 540	RTN79WYP RTN79G	.015
Y-12, Y-18, Y-24, Y-33				405	RN14YC	.030							
BARTON													
Washing Machines													
All Models BARTON				871 841	RJ8C J8C	.030							
BAUDOIN													
6 or 12 P15.2				685	S59YC	.020							
BERNARD													
All Models BERNARD	1224	RL85G	.015	830 306	RL86C L86C	.025	551	RHL79G			556	RTL85G	.015
BUDA (See Allis-Chalmers)													
CASE													
188G, 301G, 377G Gasoline				516 555	D16 UD16	.025							
188G, 301G, 377G Natural & LP Gas	233 217	RM82WPCC RM77PP	.012	519	RM77N	.015	236 222	RHM78WPCC RHM78PP	234	RHM78N	223 1201	RTM77PP RTM78N	.015
A284, A377, 159G Gasoline				516 555	D16 UD16	.025							
A284, A377, 159G Natural & LP Gas	233 217	RM82WPCC RM77PP	.012	519	RM77N	.015	236 222	RHM78WPCC RHM78PP	234	RHM78N	223 1201	RTM77PP RTM78N	.015
CATERPILLAR													
D315G D318G G3304 copy the 1/2" reach and 3/4" rache													
NATURAL GAS													
3306, G333 1/2" Reach 3306, G333 3/4" Reach, G343, G3304	1224 530	RL85G RN79G	.015 .015	535	RL15B	.015	551 575	RHL79G RHN79G			556 1232 540	RTL85G RTN79WYP RTN79G	.015 .015
G3400 Series	530	RN79G	.015				575	RHN79G			1232 540	RTN79WYP RTN79G	.015
G342, G353, G375, G379	1224 1230	RL85G FB77WPCC	.015	535	RL15B	.015	551	RHL79G			556	RTL85G	.015
G3500 Series	634 636 1230	RB77WPCC RB77WPC FB77WPCC	.012	237 643	RB77CC RB75N	.012			624	RHB81N	235	RTB77WPCC	.012
G3600 Series	634 636	RB77WPCC RB77WPC	.012	237 643	RB77CC RB75N	.012			624	RHB81N	235	RTB77WPCC	.012
G3600 Series (Sensor Plug) G3600 Series (Sensor Plug) Bulbos				227 1211	FI21505 FI21511								
G397, G398, G399	1224	RL85G	.015	535	RL15B	.015	551	RHL79G			556	RTL85G	.015
STARTING ENGINES FOR DIESELS													
14mm Heads													
D320, D339, D342, D343, D353 D330, D333				58 14 10	RJ18YC RJ12YC J12YC	.030 .030							
D375, D379, D397, D398, D4600				58	RJ18YC	.030							
18mm Heads													
D320, D326, D337				516 555	D16 UD16	.025							
D339, D342, D343, D353				516 555	D16 UD16	.025							
D375, D379, D397, D398				516 555	D16 UD16	.025							
CHRYSLER													
GASOLINE													
Light Service													
1976-75 H225, HB-225 H440				406 63 10	RV12YC RJ14YC J12YC	.035 .035							



COMMERCIAL, STATIONARY AND GAS ENGINE APPLICATIONS

MAKE YEAR and MODEL	PREMIUM LONG LIFE			COPPER PLUS UNSHIELDED			PREMIUM SHIELDED 3/4"-20		SHIELDED 3/4"-20		INTEGRAL COIL TYPE 13/16"-20		
	STOCK NO.	PLUG TYPE	GAP	STOCK NO.	PLUG TYPE	GAP	STOCK NO.	PLUG TYPE	STOCK NO.	PLUG TYPE	STOCK NO.	PLUG TYPE	GAP
CHRYSLER													
GASOLINE													
Light Service													
IND54				58	RJ18YC	.035							
				823	J6C								
LH318, H170, HB170				404	RN12YC	.035							
				38	N12YC								
Thru 1974 H225, HB-225	530	RN79G	.020	404	RN12YC	.035	575	RHN79G			1232	RTN79WYP	.020
				38	N12YC						540	RTN79G	
Normal Service													
1975-73 440-3 (Motor Home)				400	RV9YC	.035							
1976-75 H225, HB-225				406	RV12YC	.035							
1978 H105				415	RN9YC	.025							
				300	N9YC								
1978-77 HB225				406	RV12YC	.035							
1978-77 L360, LH360				404	RN12YC	.035							
				38	N12YC								
1978-77 LH318				322	RN11YC4	.035							
				302	N11YC								
H273				404	RN12YC	.035							
				38	N12YC								
H318, HB318, HC318, HT318				14	RJ12YC	.035							
				10	J12YC								
H361, H383, H413, HA318				63	RJ14YC	.035							
H440				63	RJ14YC	.035							
				10	J12YC								
HB361, HB383, HC361, HT361	530	RN79G	.020	123	RN5C	.020	575	RHN79G			1232	RTN79WYP	.020
				120	N5C						540	RTN79G	
HB413, HC413, HB170	530	RN79G	.020	123	RN5C	.020	575	RHN79G			1232	RTN79WYP	.020
				120	N5C						540	RTN79G	
HT413, HB426, HC426, H170	530	RN79G	.020	123	RN5C	.020	575	RHN79G			1232	RTN79WYP	.020
				120	N5C						540	RTN79G	
IND12A, IND19B, IND52				871	RJ8C	.035							
				841	J8C								
IND14, IND14A, IND15, IND15A				592	RJ12C	.035							
				511	J11C								
IND16A, IND 18A, IND19A, IND20A				592	RJ12C	.035							
				511	J11C								
IND23A, IND24A				504	N21	.035							
IND30, IND38, IND908A, IND931				592	RJ12C	.035							
				511	J11C								
IND31, IND32, IND33				592	RJ12C	.035							
				511	J11C								
IND53, IND56, IND56A	530	RN79G	.020	123	RN5C	.020	575	RHN79G			1232	RTN79WYP	.020
				120	N5C						540	RTN79G	
IND54				58	RJ18YC	.035							
				823	J6C								
IND5A, IND6A, IND7A				592	RJ12C	.035							
				511	J11C								
IND8A, IND13, IND13A				592	RJ12C	.035							
				511	J11C								
LH318				322	RN11YC4	.035							
				302	N11YC								
LT318				129	RF10C	.035							
Thru 1974 H225, HB-225	530	RN79G	.020	404	RN12YC	.035	575	RHN79G			1232	RTN79WYP	.020
				38	N12YC						540	RTN79G	
Severe Service													
H440				63	RJ14YC	.035							
				10	J12YC								
IND56, IND56A, LH318	530	RN79G	.020	123	RN5C	.020	575	RHN79G			1232	RTN79WYP	.020
				120	N5C						540	RTN79G	
NATURAL & LP Gas													
1977 HB225				406	RV12YC	.020							
H170, HB170, H225, HB225	530	RN79G	.020	123	RN5C	.020	575	RHN79G			1232	RTN79WYP	.020
				120	N5C						540	RTN79G	



MAKE YEAR and MODEL	PREMIUM LONG LIFE			COPPER PLUS UNSHIELDED			PREMIUM SHIELDED 3/4"-20		SHIELDED 3/4"-20		INTEGRAL COIL TYPE 13/16"-20		
	STOCK NO.	PLUG TYPE	GAP	STOCK NO.	PLUG TYPE	GAP	STOCK NO.	PLUG TYPE	STOCK NO.	PLUG TYPE	STOCK NO.	PLUG TYPE	GAP
CHRYSLER													
NATURAL & LP Gas													
H318, HB318, HC318, HT318				14	RJ12YC	.035							
				10	J12YC								
H361, H383, H413, HA318				63	RJ14YC	.035							
HB361, HB383, HC361, HT361	530	RN79G	.020	818	RN2C	.020	575	RHN79G			1232	RTN79WYP	.020
				805	N2C						540	RTN79G	
HB413, HC413, HT413, HB426, HC426	530	RN79G	.020	818	RN2C	.020	575	RHN79G			1232	RTN79WYP	.020
				805	N2C						540	RTN79G	
IND13A, IND14, IND13A, IND14A, IND15				871	RJ8C	.020							
				841	J8C								
IND15A, IND16A, IND30, IND31, IND32				871	RJ8C	.020							
				841	J8C								
IND33, IND38, IND908A, IND931				871	RJ8C	.020							
				841	J8C								
IND5A, IND6A, IND7A, IND8A, IND13				871	RJ8C	.020							
				841	J8C								
CLARK (See Dresser Clark)													
CLEVELAND DIESEL													
Model 358	1207	RW80PP	.012	545	W85N	.012	1204	RHW80PP	532	RHW80N	638	RTW80N	.012
	582	RW82P											
CLIMAX													
GASOLINE													
CE101, CE106, CE264	233	RM82WPCC	.012	519	RM77N	.015	236	RHM78WPCC	234	RHM78N	223	RTM77PP	.015
	217	RM77PP					222	RHM78PP			1201	RTM78N	
CE46, CE66, CE81, CE96				514	D14	.025							
R-165 Snowplow Only				516	D16	.025			563	XED16			.025
				555	UD16								
V-80, V-85, V-122, V-125 8.2:1 C.R.				514	D14	.015							
V-80, V-85, V-122, V-125 9.4:1 C.R.	233	RM82WPCC	.012	519	RM77N	.015	236	RHM78WPCC	234	RHM78N	223	RTM77PP	.015
	217	RM77PP					222	RHM78PP			1201	RTM78N	
COMPESCO													
Search for model - Natural gas pipe line													
CONTINENTAL													
ALL FUELS													
B20, 371, 421, R513, R572, R602				509	D9	.025							
N56 to 62, N4062, NA82, TS415				509	D9	.020							
S6749 to 6820, Y69, Y91, Y112				509	D9	.020							
U501, Z129, 134				509	D9	.025							
GASOLINE													
Normal Service													
700, 800, 900, 1100, 1200				871	RJ8C	.030							
				841	J8C								
All Other 14mm Heads				102	RJ6C	.025							
				823	J6C								
B405, 4124, 4140, 4162, 4163, 6226				516	D16	.025							
				555	UD16								
B6244, 6245, 6277, 6371, 6405, 6427				516	D16	.025							
				555	UD16								
C46, C66				543	D89D	.025							
C96, C106, C225				502	D21	.025							
E223, F124, 135, 140, 162, 163, 186				516	D16	.025							
				555	UD16								
F209, 226, 227, 244, 245				516	D16	.025							
				555	UD16								
FO6228				404	RN12YC	.030							
				38	N12YC								
G134, 157, 176, H227, 243, 260				516	D16	.025							
				555	UD16								
G193, K6271, 6298, 6330, 6363				871	RJ8C	.025							
				841	J8C								
G4193									857	RH18Y			.030
J382 to 403, T371 to 247				516	D16	.025							
				555	UD16								



COMMERCIAL, STATIONARY AND GAS ENGINE APPLICATIONS

MAKE YEAR and MODEL	PREMIUM LONG LIFE			COPPER PLUS UNSHIELDED			PREMIUM SHIELDED 3/4"-20		SHIELDED 3/4"-20		INTEGRAL COIL TYPE 13/16"-20		
	STOCK NO.	PLUG TYPE	GAP	STOCK NO.	PLUG TYPE	GAP	STOCK NO.	PLUG TYPE	STOCK NO.	PLUG TYPE	STOCK NO.	PLUG TYPE	GAP
CONTINENTAL													
GASOLINE													
Normal Service													
L478				825	J4C	.025							
L6478				102	RJ6C	.025							
				823	J6C								
M6271, 6290, 6330, 6363, OS220				516	D16	.025							
				555	UD16								
Multi-Tool				592	RJ12C	.025							
				511	J11C								
R11, 14, 17				327	RL87YC	.025							
				312	L87YC								
R6513, 6572, 6602, U6501 14mm Heads				871	RJ8C	.025							
				841	J8C								
R6513, 6572, 6602, U6501 18mm Heads				516	D16	.025							
				555	UD16								
R688-46, R800-46, R810-46, R839-46				327	RL87YC	.025							
				312	L87YC								
RS542, T6371, 6427, TC56				516	D16	.025							
				555	UD16								
TM13, 20, 27				415	RN9YC	.035							
				300	N9YC								
TS415, Z134				509	D9	.025							
Y69, Y91, Y112, Y4069, 4091, 4112				516	D16	.025							
				555	UD16								
Z105 to 120, ZA120				516	D16	.025							
				555	UD16								
Severe Service													
F4163, F6227, F6245				509	D9	.025							
NATURAL & LP GAS													
All Other 14mm Heads													
				102	RJ6C	.025							
				823	J6C								
C46, C66, C96, C106, C255				502	D21	.025							
				543	D89D								
E223, F124, 162, 224, 226				509	D9	.020							
G193				102	RJ6C	.020							
				823	J6C								
H280, 277, M271, 290, 330, 363				509	D9	.020							
J382 to 403				509	D9	.020							
S749, T247, 371 to 427				509	D9	.020							
COOPER - BESSEMER													
Shielded													
GAW, GMR, GMV, JS	1207	RW80PP	.012	545	W85N	.015	1204	RHW80PP	532	RHW80N	638	RTW80N	.015
	582	RW82P		580	W80N		578	REW82P	534	REW80N	638	RTW80N	
GMW, GMX V-250, V-275 5/8" Reach							578	REW82P	534	REW80N			.015
GMWA, GMWC 5/8" Reach							578	REW82P	534	REW80N			.015
GMWA, GMWC, GMW, GMX, V-250, V-275, Z330 1"Rch.									635	RHW78N			.012
GMXE, GMWH, GMXH, W330 1" Reach									635	RHW78N			.012
GMXE, GMWH, GMXH, W330 5/8" Reach							578	REW82P	534	REW80N			.015
Unshielded													
ENG, GNG	233	RM82WPCC	.012	519	RM77N	.015	236	RHM78WPCC	222	RHM78PP	223	RTM77PP	.015
	217	RM77PP		529	D14N				234	RHM78N	1201	RTM78N	
GAB, GAF, GAG, GAJ, GAN				513	C97B	.025							
GAO, GAOA, GAR, GAU, GBE, GBE, GBG				513	C97B	.025							
GAS, EN, ENB; 'Hope' 14-3/4" x 16"				513	C97B	.025							
GAW, GMR, GMV, JS	1207	RW80PP	.012	545	W85N	.015	1204	RHW80PP	532	RHW80N	638	RTW80N	.015
	582	RW82P		580	W80N		578	REW82P	534	REW80N	638	RTW80N	
GBH, GBI, GBK				518	W18	.025							
GBM thru GBP, GN, GSC, GSD				518	W18	.025							
GDA thru GDS, GHA, GHB, GMD				513	C97B	.025							
GDJ, GMA, GMB, GMC w/G402 Reducing Bushing	233	RM82WPCC	.012	519	RM77N	.015	236	RHM78WPCC	222	RHM78PP	223	RTM77PP	.015
	217	RM77PP		529	D14N				234	RHM78N	1201	RTM78N	



MAKE YEAR and MODEL	PREMIUM LONG LIFE			COPPER PLUS UNSHIELDED			PREMIUM SHIELDED 3/4"-20		SHIELDED 3/4"-20		INTEGRAL COIL TYPE 13/16"-20		
	STOCK NO.	PLUG TYPE	GAP	STOCK NO.	PLUG TYPE	GAP	STOCK NO.	PLUG TYPE	STOCK NO.	PLUG TYPE	STOCK NO.	PLUG TYPE	GAP
COOPER - BESSEMER													
Unshielded													
GDT, GFB, GFE, GFK w/G402 Reducing Bushing	233	RM82WPCC	.012	519	RM77N	.015	236	RHM78WPCC	222	RHM78PP	223	RTM77PP	.015
	217	RM77PP		529	D14N				234	RHM78N	1201	RTM78N	
GMG, GMO, GMOA, GRC				513	C97B	.025							
				513	C97B								
GMVH, LSVB	228	RW77PP	.012	565	RW77N	.015			635	RHW78N	552	RGC77N	.015
				631	RW78N								
GMW, GMX, V-250, V-275, W330 5/8" Reach	1207	RW80PP	.012	553	RW80N	.015	1204	RHW80PP	532	RHW80N	638	RTW80N	.015
	582	RW82P		580	W80N								
GMWA, GMWC, GMW, GMX, V-250, V-275, Z330 1" Reach	228	RW77PP	.012	565	RW77N	.012			635	RHW78N	552	RGC77N	.012
				631	RW78N								
GMWC, GMWA 5/8" Reach	1207	RW80PP	.012	553	RW80N	.015	1204	RHW80PP	532	RHW80N	638	RTW80N	.015
	582	RW82P		580	W80N								
GMXE, GMWH, GMXH 5/8" Reach	1207	RW80PP	.012	553	RW80N	.015	1204	RHW80PP	532	RHW80N	638	RTW80N	.015
	582	RW82P		580	W80N								
GMXE, GMWH, GMXH, W330 1"Rch.	228	RW77PP	.012	565	RW77N	.012			635	RHW78N	552	RGC77N	.012
				631	RW78N								
GS				555	UD16	.025							
"Hope" 18" x 20"				525	25	.025							
LS, LSV 1-1/8"-12 Heads				598	RS79N	.012							
LS, LSV 7/8"-18 Heads				510	W10	.015							
				580	W80N								
Quad Series	228	RW77PP	.012	565	RW77N	.012			635	RHW78N	552	RGC77N	.012
				631	RW78N								
Z330 5/8" Reach	1207	RW80PP	.012	553	RW80N	.015	1204	RHW80PP	532	RHW80N	638	RTW80N	.015
	582	RW82P		580	W80N								
COOPER ENERGY SERVICES (See Superior)													
CP - CHICAGO PNEUMATIC													
16CPG, RHGB-50				518	W18	.025							
9CPG High Compression									534	REW80N			.015
9CPG Low Compression				516	D16	.025							
				555	UD16								
Cat. D13000 And Other 7/8"-18 Heads				569	W14	.025							
CUMMINS													
6B				2095	2095	.020							
6B w/230 hp	1206	RC78WP	.017	1209	RC78YCC15	.017							
	1208	RC78PYP											
6C	1206	RC78WP	.017	1209	RC78YCC15	.017							
	1208	RC78PYP											
	1230	FB77WPCC											
FTA19GC SLB	634	RB77WPCC	.012	237	RB77CC	.012			624	RHB81N	235	RTB77WPCC	.012
	636	RB77WPC		643	RB75N								
G3.9	1206	RC78WP	.017	1209	RC78YCC15	.015							
	1208	RC78PYP											
G5.9	1206	RC78WP	.017	1209	RC78YCC15	.015							
	1208	RC78PYP											
G5.9e	1206	RC78WP	.017	1209	RC78YCC15	.015							
	1208	RC78PYP											
G8.3	1206	RC78WP	.017	1209	RC78YCC15	.015							
	1208	RC78PYP											
G8.3e	1206	RC78WP	.017	1209	RC78YCC15	.015							
	1208	RC78PYP											
	1230	FB77WPCC											
G855	634	RB77WPCC	.012	237	RB77CC	.012			624	RHB81N	235	RTB77WPCC	.012
	636	RB77WPC		643	RB75N								
	1230	FB77WPCC											
G855e	634	RB77WPCC	.012	237	RB77CC	.012			624	RHB81N	235	RTB77WPCC	.012
	636	RB77WPC		643	RB75N								
GM11													
GNHC-4, GNH-220, GNH-250 1/2" Reach	1224	RL85G	.025	535	RL15B	.025	551	RHL79G			556	RTL85G	.025
GNHC-4, GNH-220, GNH-250 3/8" Reach				825	J4C	.025							



COMMERCIAL, STATIONARY AND GAS ENGINE APPLICATIONS

MAKE YEAR and MODEL	PREMIUM LONG LIFE			COPPER PLUS UNSHIELDED			PREMIUM SHIELDED 3/4"-20		SHIELDED 3/4"-20		INTEGRAL COIL TYPE 13/16"-20		
	STOCK NO.	PLUG TYPE	GAP	STOCK NO.	PLUG TYPE	GAP	STOCK NO.	PLUG TYPE	STOCK NO.	PLUG TYPE	STOCK NO.	PLUG TYPE	GAP
CUMMINS													
GTA 8.3	1206	RC78WP	.017	1209	RC78YCC15	.015							
	1208	RC78PYP											
GTA8.3 SLB	1206	RC78WP	.017	1209	RC78YCC15	.015							
	1208	RC78PYP											
	1230	FB77WPCC											
GTA855	634	RB77WPCC	.012	237	RB77CC	.012			624	RHB81N	235	RTB77WPCC	.012
	636	RB77WPC		643	RB75N								
	1230	FB77WPCC											
GTA855e	634	RB77WPCC	.012	237	RB77CC	.012			624	RHB81N	235	RTB77WPCC	.012
	636	RB77WPC		643	RB75N								
GV-12450, GM-12-525 3/8" Reach				825	J4C	.025							
GV-12450, GV-12-525 1/2" Reach	1224	RL85G	.025	535	RL15B	.025	551	RHL79G			556	RTL85G	.025
	1230	FB77WPCC											
KTA19GC	634	RB77WPCC	.012	237	RB77CC	.012			624	RHB81N	235	RTB77WPCC	.012
	636	RB77WPC		643	RB75N								
	1230	FB77WPCC											
KTA38GC SLB	634	RB77WPCC	.012	237	RB77CC	.012			624	RHB81N	235	RTB77WPCC	.012
	636	RB77WPC		643	RB75N								
L-10	219	RC78PYP	.021										
L10CNG	1230	FB77WPCC											
Q19G	634	RB77WPCC	.012	237	RB77CC	.012			624	RHB81N	235	RTB77WPCC	.012
	636	RB77WPC		643	RB75N								
	1230	FB77WPCC											
QSV 81-V16	634	RB77WPCC	.012	237	RB77CC	.012			624	RHB81N	235	RTB77WPCC	.012
	636	RB77WPC		643	RB75N								
	1230	FB77WPCC											
QSV 91-V18	634	RB77WPCC	.012	237	RB77CC	.012			624	RHB81N	235	RTB77WPCC	.012
	636	RB77WPC		643	RB75N								
Engines w/Special Adapter													
No. 173416 5/8" Reach w/N677 Gasket	530	RN79G	.025	818	RN2C	.025	575	RHN79G			1232	RTN79WYP	.025
				805	N2C						540	RTN79G	
No. 90210035, 90210036 3/4" Reach	530	RN79G	.025	818	RN2C	.025	575	RHN79G			1232	RTN79WYP	.025
				805	N2C						540	RTN79G	
VHP SERIES													
V-16													
9390G, P9390GSI	233	RM82WPCC	.012	519	RM77N	.015	236	RHM78WPCC	234	RHM78N	223	RTM77PP	.015
	217	RM77PP					222	RHM78PP			1201	RTM78N	
DECO-GRAND													
AU7B, DE8									567	XEJ12			.025
DE2, DE2R, DE3, DE3R, DE7R, DEA8				871	RJ8C	.025							
				841	J8C								
DELAVAL													
1980-69 HV-8, HV-12, HV-16	228	RW77PP	.012	206	RW77N	.015			577	RHW77N	552	RGC77N	.015
				539	W77N								
1980-72 HA6, HVA-8	228	RW77PP	.012	206	RW77N	.015			577	RHW77N	552	RGC77N	.015
				539	W77N								
1980-73 HVA-16	228	RW77PP	.012	206	RW77N	.015			577	RHW77N	552	RGC77N	.015
				539	W77N								
1980-74 HVA-12	228	RW77PP	.012	206	RW77N	.015			577	RHW77N	552	RGC77N	.015
				539	W77N								
DETROIT DIESEL													
149 Series	1230	FB77WPCC											
30, 40, 50 Series	243	RC78PYP15	.015										
	1205	RB77WPCC											
92 Series													
DEUTZ MWM													
G620 V-8, TBG616 V-8, TBG616 V-12	242	RB75WPCC	.012										
TBG616K V-8K, TBG616K V-12K, TBG616K V-16K	242	RB75WPCC	.012										
TBG620 V-8, TBG620 V-12, TBG620 V-16	242	RB75WPCC	.012										
TBG620K V-12K, TGB620K V-16K	242	RB75WPCC	.012										



MAKE YEAR and MODEL	PREMIUM LONG LIFE			COPPER PLUS UNSHIELDED			PREMIUM SHIELDED 3/4"-20		SHIELDED 3/4"-20		INTEGRAL COIL TYPE 13/16"-20		
	STOCK NO.	PLUG TYPE	GAP	STOCK NO.	PLUG TYPE	GAP	STOCK NO.	PLUG TYPE	STOCK NO.	PLUG TYPE	STOCK NO.	PLUG TYPE	GAP
DORMAN													
12S, 12STCWG, 12STCAG, 6PG, 12PG	233	RM82WPCC	.012	519	RM77N	.015	236	RHM78WPCC	234	RHM78N	223	RTM77PP	.015
	217	RM77PP		529	D14N		222	RHM78PP			1201	RTM78N	
12SG	233	RM82WPCC	.012	519	RM77N	.015	236	RHM78WPCC	234	RHM78N	223	RTM77PP	.015
	217	RM77PP		566	M82N		222	RHM78PP			1201	RTM78N	
3DAG, 4DAG, 6DAG, 6QG, DATG4, 6	530	RN79G	.015	880	RN3C	.015	575	RHN79G			1232	RTN79WYP	.015
				801	N3C						540	RTN79G	
6LEG	1224	RL85G	.015	874	RL82C	.015	551	RHL79G			556	RTL85G	.015
				811	L82C								
6PG, 12PG	233	RM82WPCC	.012	519	RM77N	.015	236	RHM78WPCC	234	RHM78N	223	RTM77PP	.015
	217	RM77PP		529	D14N		222	RHM78PP			1201	RTM78N	
6SEG, 8SEG, 12SEG	530	RN79G	.015				575	RHN79G			1232	RTN79WYP	.015
											540	RTN79G	
6SETCWG				685	S59YC	.015							
6SETCWG MinNox	530	RN79G	.015				575	RHN79G			1232	RTN79WYP	.015
											540	RTN79G	
DRESSER CLARK													
BA, HBA, HMA, HLA, HRA, MA	1207	RW80PP	.012	545	W85N	.012	1204	RHW80PP	532	RHW80N	638	RTW80N	.012
	582	RW82P											
RA, TRA, TLA, TCV	1207	RW80PP	.012	545	W85N	.012	1204	RHW80PP	532	RHW80N	638	RTW80N	.012
	582	RW82P											
Supercharged & Turbocharged													
HBAT, HLAT, HRAT, TRA, TLA	1207	RW80PP	.012	553	RW80N	.012	1204	RHW80PP	532	RHW80N	638	RTW80N	.012
	582	RW82P		580	W80N								
TCVB, TCVC, TVM, VMC	1207	RW80PP	.012	553	RW80N	.012	1204	RHW80PP	532	RHW80N	638	RTW80N	.012
	582	RW82P		580	W80N								
TLAB, TLAC, TLAD, TPV, TCVA	1207	RW80PP	.012	553	RW80N	.012	1204	RHW80PP	532	RHW80N	638	RTW80N	.012
	582	RW82P		580	W80N								
TVC, HSRA, RAS, TMB	1207	RW80PP	.012	553	RW80N	.012	1204	RHW80PP	532	RHW80N	638	RTW80N	.012
	582	RW82P		580	W80N								
DRESSER RAND													
KVG Pulse Chamber Type	1207	RW80PP	.012	559	RW83F	.012	1204	RHW80PP	544	HW83F	645	RTW83F	.012
	582	RW82P											
KVSR, KVSRA, KVSE, KVFS, PKVSE	228	RW77PP	.012	565	RW77N	.012			635	RHW78N	552	RGC77N	.012
				631	RW78N								
TCV, TCVA, TCVD, TLAD	1207	RW80PP	.012	553	RW80N	.012	1204	RHW80PP	532	RHW80N	638	RTW80N	.012
	582	RW82P		580	W80N								
DRESSER Waukesha													
See Waukesha													
ECHO													
KEH202D, SV2 (Kioritz)				840	RCJ8	.025							
				843	CJ8								
ENTERPRISE													
GSG-36, 38; GSM-36, 38	226	RB76PP	.012	576	RB76N	.012			624	RHB81N	235	RTB77WPCC	.012
GSM-36, 38 Unshielded 18mm Heads	226	RB76PP	.012	576	RB76N	.012			624	RHB81N	235	RTB77WPCC	.012
GSM-36, 38 Unshielded 7/8"-18 Heads	1207	RW80PP	.012	553	RW80N	.012	1204	RHW80PP	532	RHW80N	638	RTW80N	.012
	582	RW82P		580	W80N								
HV-8, HV-12, HV-16	228	RW77PP	.012	206	RW77N	.015	1204	RHW80PP	577	RHW77N	552	RGC77N	.015
				539	W77N								
TDSG-36-6-38 Center of Head	1207	RW80PP	.012	553	RW80N	.012	1204	RHW80PP	532	RHW80N	638	RTW80N	.012
	582	RW82P		580	W80N								
TDSG-36-6-38 Rear Side Of Head	226	RB76PP	.012	576	RB76N	.012			624	RHB81N	235	RTB77WPCC	.012
FAIRBANKS MORSE													
38D8-1/8 Series	233	RM82WPCC	.012	571	RM79F	.015	236	RHM78WPCC	234	RHM78N	223	RTM77PP	.012
	217	RM77PP					222	RHM78PP			1201	RTM78N	
38DS8-1/8, 38F-85, 38FS5-1/4	226	RB76PP	.012	576	RB76N	.012			624	RHB81N	235	RTB77WPCC	.012
FM-7, FM-12, FM-18, FM-24, FM-36				589	W89D	.025							
ZC, ZC118, ZC208, ZC346				589	W89D	.025							
ZC346, ZC503, ZC739				589	W89D	.025							
FICHTEL-SACHS (See Sachs)													
FORD													
104 cid				322	RN11YC4	.035							
				302	N11YC								



COMMERCIAL, STATIONARY AND GAS ENGINE APPLICATIONS

MAKE YEAR and MODEL	PREMIUM LONG LIFE			COPPER PLUS UNSHIELDED			PREMIUM SHIELDED 3/4"-20		SHIELDED 3/4"-20		INTEGRAL COIL TYPE 13/16"-20		GAP
	STOCK NO.	PLUG TYPE	GAP	STOCK NO.	PLUG TYPE	GAP	STOCK NO.	PLUG TYPE	STOCK NO.	PLUG TYPE	STOCK NO.	PLUG TYPE	
FORD													
140 cid (2.3L)				401	RS12YC	.035							
144, 170 cid				22	RF11YC	.035							
153 cid (2.5L)				401	RS12YC	.035							
158, 175, 201, 256 cid	530	RN79G	.020	123	RN5C	.020	575	RHN79G			1232	RTN79WYP	.020
				120	N5C						540	RTN79G	
182 cid (3.0L)				332	RN7YC	.035							
200, 240, 250, 262, 292 cid				129	RF10C	.030							
223, 272 cid				409	RF9YC	.030							
300 cid (4.9L)				22	RF11YC	.030							
330, 332, 361, 391, 401 cid				129	RF10C	.030							
460, 429, 351, 302, 370 cid				406	RV12YC	.035							
477 cid 1977 & Up				106	RZF10	.035							
477 cid Thru 1977				129	RF10C	.035							
534 cid 1976 & Up				106	RZF10	.035							
534 cid Thru 1976				129	RF10C	.030							
67 cid (1.1L)				415	RN9YC	.035							
				300	N9YC								
79 cid (1.3L)				304	RS9YC	.035							
91, 120, 134, 172, 192 cid Gasoline									854	RH10C			.025
									844	H10C			
91, 120, 134, 172, 192 cid LP Gas									538	RH8C			.020
									587	H8C			
98 cid (1.6L)				415	RN9YC	.035							
				300	N9YC								
CSG 850, CSG 850M-EFI				406	RV12YC	.035							
LSG 875				406	RV12YC	.035							
WSG 858, WSG 858-HO				406	RV12YC	.035							
WSG 858, WSG 858-HO EFI, LSG875				406	RV12YC	.035							
FUJI-ROBIN													
EC-02, EC-02R				849	CJ6	.025							
EC-05, EC-07, FG-14	1224		.025	830	RL86C	.025	551	RHL79G			556	RTL85G	.025
	RL85			306	L86C								
	G												
EC-10, EY-21				871	RJ8C	.030							
				841	J8C								
EY-13, EY-18, EY-25, EY-33	1224		.025	830	RL86C	.025	551	RHL79G			556	RTL85G	.025
	RL85			306	L86C								
	G												
EY-27, EY-14, EY-40, EC-16	1224		.025	830	RL86C	.025	551	RHL79G			556	RTL85G	.025
	RL85			306	L86C								
	G												
EY-44, EY-88, EC-03, EC-04	1224		.025	830	RL86C	.025	551	RHL79G			556	RTL85G	.025
	RL85			306	L86C								
	G												
Series FA, KB, KD, KE, KH, KM				871	RJ8C	.030							
				841	J8C								
Kerosene Engines													
EY-13, EY-18, EY-25, EY-33, EY-44				806	L92YC	.025							
GEMINI													
G26, G35	1224	RL85G	.025	874	RL82C	.025	551	RHL79G			556	RTL85G	.025
				811	L82C								
GENERAL MOTORS													
16-358HN, 16-358-X	1207	RW80PP	.012	545	W85N	.012	1204	RHW80PP	532	RHW80N	638	RTW80N	.012
	582	RW82P											
305, 351, 401, 478, 702 Gasoline	530	RN79G	.025	104	RN4C	.025	575	RHN79G			1232	RTN79WYP	.025
				803	N4C						540	RTN79G	
305, 351, 401, 478, 702 LPG	530	RN79G	.025	880	RN3C	.020	575	RHN79G			1232	RTN79WYP	.020
				801	N3C						540	RTN79G	
GUASCOR													
FG180, FG180, FG240	1230	FB77WPCC											
	634	RB77WPCC	.012	237	RB77CC	.012			624	RHB81N	235	RTB77WPCC	.012
	636	RB77WPC		643	RB75N								
	1230	FB77WPCC											



MAKE YEAR and MODEL	PREMIUM LONG LIFE			COPPER PLUS UNSHIELDED			PREMIUM SHIELDED 3/4"-20		SHIELDED 3/4"-20		INTEGRAL COIL TYPE 13/16"-20		GAP
	STOCK NO.	PLUG TYPE	GAP	STOCK NO.	PLUG TYPE	GAP	STOCK NO.	PLUG TYPE	STOCK NO.	PLUG TYPE	STOCK NO.	PLUG TYPE	
GUASCOR													
FGLD240, FGLD360, FGLD480	634	RB77WPCC	.012	237	RB77CC	.012			624	RHB81N	235	RTB77WPCC	.012
	636	RB77WPC		643	RB75N								
HGM 560	1230	FB77WPCC											
SFGLD 180, SFGLD 240, SFGLD 360, SFGLD 480, SFGLD 560	634	RB77WPCC	.012	237	RB77CC	.012			624	RHB81N	235	RTB77WPCC	.012
	636	RB77WPC		643	RB75N								
HALL SCOTT													
GASOLINE													
1091-G1 Intake				502	D21	.025							
1091-OS Intake				516	D16	.025							
				555	UD16								
136, 180, 190, 504 Exhaust				514	D14	.025							
151, 152, 165, 167				569	W14	.025							
200-0, 201-0; 400-0 Regular				514	D14	.025							
400-0 Water-Jacketed Exhaust				509	D9	.025							
400-0, 300, 470, 480 Intake				502	D21	.025							
400-0, 470, 480 Sour Gas				597	K97F	.020							
400-0, 470, 480, 6156 Exhaust				514	D14	.025							
440, 2269-0; 1091-OS Exhaust				514	D14	.025							
590 Series				102	RJ6C	.025							
				823	J6C								
6156, FE, G1, G2 Intake				502	D21	.025							
6156-B1, 6182-B1, 1091-B1 Exhaust				506	D6	.025							
6156-B1, 6182-B1, 1091-B1 Intake				514	D14	.025							
6182, G1, G2, FE Intake				502	D21	.025							
779-GHI				516	D16	.025							
				555	UD16								
855, 935 Exhaust				506	D6	.025							
855, 935 Intake				502	D21	.025							
F3, G1, G2, 6182 Exhaust				514	D14	.025							
G1, G2, FE; 1091G1 Exhaust				514	D14	.025							
NATURAL & LP GAS													
400-0, 470, 480, 855, 935 Exhaust				506	D6	.020							
400-0, 470, 480, 855, 935 Intake				514	D14	.020							
590 Series				825	J4C	.025							
HERCULES													
1091-OS Exhaust				514	D14	.025							
1091-OS Intake				516	D16	.025							
				555	UD16								
1404				14	RJ12YC	.025							
				10	J12YC								
149H, 169H, 198AH, L237				102	RJ6C	.025							
				823	J6C								
14mm Heads Using Natural Gas				825	J4C	.015							
6156, 6182 Natural & LP Gas Exhaust				506	D6	.025							
6156, 6182 Natural & LP Gas Intake				514	D14	.025							
GTA 3.7, GTA 5.6	219	RC78PYP	.025										
HXE, HXLEF				516	D16	.025							
				555	UD16								
IXB				592	RJ12C	.025							
				511	J11C								
IXLB, JXC, JXD, JXLD, 14mm Heads				871	RJ8C	.025							
				841	J8C								
JXLD, JXC 18mm Heads				509	D9	.025							
JXLDER, IXBER, NXB, JX4LD				871	RJ8C	.025							
				841	J8C								
QXC, QXD, JX4C, GO6, JX4S, RXC				871	RJ8C	.025							
				841	J8C								
RXLDH, C2-90D, IXA, QXLD, GO4				871	RJ8C	.025							
				841	J8C								
Thermo King	644	RJ88P	.015										
Normal Service													



COMMERCIAL, STATIONARY AND GAS ENGINE APPLICATIONS

MAKE YEAR and MODEL	PREMIUM LONG LIFE			COPPER PLUS UNSHIELDED			PREMIUM SHIELDED 3/4"-20		SHIELDED 3/4"-20		INTEGRAL COIL TYPE 13/16"-20		
	STOCK NO.	PLUG TYPE	GAP	STOCK NO.	PLUG TYPE	GAP	STOCK NO.	PLUG TYPE	STOCK NO.	PLUG TYPE	STOCK NO.	PLUG TYPE	GAP
HERCULES													
Normal Service CV4-180, CV4-180ER				871	RJ8C	.025							
G-1000 Natural & LP Gas				841	J8C								
G298H				102	RJ6C	.025							
G3400 Power Unit (Magneto Ignition)				823	J6C								
G4800, GTA4800	1206	RC78WP	.015	102	RJ6C	.030							
GO Series 226, 298, 339, 226AH	218	RC78PYP		823	J6C								
GO3, QXB, WXLC, GO				102	RJ6C	.025							
G-Series 1400, 1500, 1600, 1700				823	J6C								
G-Series 2000, 2300, 3000, 3400				102	RJ6C	.030							
				823	J6C								
HOFFCO													
Powerhead (Power Products AV52)				840	RCJ8	.030							
Powerhead (Tecumseh Engines)				843	CJ8								
				871	RJ8C	.030							
				841	J8C								
HOPE (See Cooper-Bessemer)													
INGERSOLL - RAND													
Naturally Aspirated PKVG, KVGR, PKVGR	1207	RW80PP	.012	553	RW80N	.012	1204	RHW80PP	532	RHW80N	638	RTW80N	.012
	1207	RW80PP		580	W80N								
XVG, PVG, JVG, SVG, KVG, PJV, PSVG	1207	RW80PP	.012	553	RW80N	.012	1204	RHW80PP	532	RHW80N	638	RTW80N	.012
	1207	RW80PP		580	W80N								
KVS, KVR, KVSR w/Precombustion Chamber	228	RW77PP	.015	565	RW77N	.015			577	RHW77N	552	RGC77N	.015
				631	RW78N								
KVS-AT Thru ET Series	1207	RW80PP	.012	559	RW83F	.012	1204	RHW80PP	544	HW83F	645	RTW83F	.012
	582	RW82P											
KVS-FT Series on Thru 1977	1207	RW80PP	.012	559	RW83F	.012	1204	RHW80PP	544	HW83F	645	RTW83F	.012
	582	RW82P											
Thru 1977 KVR, KVSR	1207	RW80PP	.012	559	RW83F	.012	1204	RHW80PP	544	HW83F	645	RTW83F	.012
	582	RW82P											
Turbocharged Models	1207	RW80PP	.012	553	RW80N	.012	1204	RHW80PP	532	RHW80N	638	RTW80N	.012
	1207	RW80PP		580	W80N								
TVS, TVR, SVS, KVT, KVH	1207	RW80PP	.012	559	RW83F	.012	1204	RHW80PP	544	HW83F	645	RTW83F	.012
	582	RW82P											
PULSE GENERATOR IGNITION KVS, PKVG, KVGR, PKVGR	1207	RW80PP	.012	559	RW83F	.012	1204	RHW80PP	544	HW83F	645	RTW83F	.012
	582	RW82P											
INTERNATIONAL													
GASOLINE													
Light Service													
U175, UC175, UC200, UC221, UC263				549	D18Y	.025							
U220, UB220, U240, UB240				10	J12YC	.030							
				823	J6C								
U308, UB308, UV345, U372, UV392				10	J12YC	.030							
				823	J6C								
UB264, UV266, U282, UV304				10	J12YC	.030							
				823	J6C								
UC301, U164, U169, U281				549	D18Y	.025							
UC60, U123, UC135, UC135B, UC153				549	D18Y	.025							
UR501, RV549, U269, UR372				14	RJ12YC	.030							
				10	J12YC								
UV401, U450, UR450, UV461, U501				10	J12YC	.030							
				823	J6C								
Normal Service													



MAKE YEAR and MODEL	PREMIUM LONG LIFE			COPPER PLUS UNSHIELDED			PREMIUM SHIELDED 3/4"-20		SHIELDED 3/4"-20		INTEGRAL COIL TYPE 13/16"-20		
	STOCK NO.	PLUG TYPE	GAP	STOCK NO.	PLUG TYPE	GAP	STOCK NO.	PLUG TYPE	STOCK NO.	PLUG TYPE	STOCK NO.	PLUG TYPE	GAP
INTERNATIONAL													
GASOLINE													
Normal Service													
C-152, C-196, C-304, C-345, C-392				14	RJ12YC	.030							
				10	J12YC								
C-446				304	RS9YC	.035							
				408	RS14YC								
C-537, C-605	530	RN79G	.015	322	RN11YC4	.020	575	RHN79G			1232	RTN79WYP	.015
				302	N11YC						540	RTN79G	
C-549				102	RJ6C	.030							
				823	J6C								
T340				509	D9	.025							
U164, U169, U175				516	D16	.025							
				555	UD16								
U164, U169, U175 Shielded									563	XED16			.025
U2, U2A, UC60, UC135				516	D16	.025							
				555	UD16								
U2, U2A, UC60, UC135 Shielded									563	XED16			.025
UB240, UV266				102	RJ6C	.030							
				823	J6C								
UC135B, UC153				516	D16	.025							
				555	UD16								
UC135B, UC153 Shielded									563	XED16			.025
UC135B, UC153, UC175				526	RD15Y	.025							
				515	D15Y								
UC175, UC200, UC301									516	D16			.025
									555	UD16			
UC175, UC200, UC301 Shielded									563	XED16			.025
UC200, UC221, UC263, UC301, T6				526	RD15Y	.025							
				515	D15Y								
UC221, UC263				516	D16	.025							
				555	UD16								
UC221, UC263 Shielded									563	XED16			.025
UR372, UV304, UV345, UV392				102	RJ6C	.030							
				823	J6C								
Severe Service													
C-446				304	RS9YC	.035							
				408	RS14YC								
U175, UC175, UC200, UC221, UC263				506	D6	.025							
U220, UB220, U240, UB240				10	J12YC	.030							
				823	J6C								
U308, UB308, UV345, U372, UV392				10	J12YC	.030							
				823	J6C								
UB264, UV266, U282, UV304				10	J12YC	.030							
				823	J6C								
UC301, U164, U169, U264, U281				506	D6	.025							
UC60, U123, UC135, UC135B, UC153				506	D6	.025							
UR501, UV549, U269, UR372				102	RJ6C	.030							
				823	J6C								
UV401, U450, UR450, UV461, U501				10	J12YC	.030							
				823	J6C								
NATURAL & LP-GAS													
C-152, C-196, C-304, C-345, C-392				14	RJ12YC	.030							
				10	J12YC								
C-446 Normal Service				408	RS14YC	.020							
C-446 Severe Service				304	RS9YC	.020							
C-537, C-605	530	RN79G	.015	322	RN11YC4	.020	575	RHN79G			1232	RTN79WYP	.015
				120	N5C						540	RTN79G	
C-549				102	RJ6C	.030							
				823	J6C								
U175, UC153, UC175				526	RD15Y	.015							
				515	D15Y								
U220, UB220, U240, UB240				10	J12YC	.030							
				823	J6C								
U308, UB308, UV345, U372, UV392				10	J12YC	.030							
				823	J6C								



COMMERCIAL, STATIONARY AND GAS ENGINE APPLICATIONS

MAKE YEAR and MODEL	PREMIUM LONG LIFE			COPPER PLUS UNSHIELDED			PREMIUM SHIELDED 3/4"-20		SHIELDED 3/4"-20		INTEGRAL COIL TYPE 13/16"-20		
	STOCK NO.	PLUG TYPE	GAP	STOCK NO.	PLUG TYPE	GAP	STOCK NO.	PLUG TYPE	STOCK NO.	PLUG TYPE	STOCK NO.	PLUG TYPE	GAP
INTERNATIONAL													
NATURAL & LP-GAS													
U817, U817B, UT817, UT817B 14mm Heads	1224	RL85G	.015	535	RL15B	.015	551	RHL79G			556	RTL85G	.015
U817, U817B, UT817, UT817B 18mm Heads				129	RF10C	.015							
UB264, UV266, U282, UV304				10	J12YC	.030							
				823	J6C								
UC135, UC135B, U164, U169				526	RD15Y	.015							
				515	D15Y								
UC221, UC263, UC301, U264, U281				526	RD15Y	.015							
				515	D15Y								
UC60, UC200				526	RD15Y	.015							
				515	D15Y								
UR501, U269, UR372, UV549				102	RJ6C	.020							
				823	J6C								
UV401, U450, UR450, UV461, U501				10	J12YC	.030							
				823	J6C								
JENBACHER													
BR3													
J208 8-Cyl., J212 12-Cyl.	226	RB76PP	.012	576	RB76N	.012			624	RHB81N	235	RTB77WPCC	.012
J216 16-Cyl., J312 12-Cyl.	226	RB76PP	.012	576	RB76N	.012			624	RHB81N	235	RTB77WPCC	.012
J316 16-Cyl., J320 20-Cyl.	226	RB76PP	.012	576	RB76N	.012			624	RHB81N	235	RTB77WPCC	.012
	1230	FB77WPCC											
J612 12-Cyl. After 9/95	634	RB77WPCC	.012	237	RB77CC	.012			624	RHB81N	235	RTB77WPCC	.012
	636	RB77WPC		643	RB75N								
J612 12-Cyl. Thru 8/95	226	RB76PP	.012	576	RB76N	.012			624	RHB81N	235	RTB77WPCC	.012
	1230	FB77WPCC											
J616 16-Cyl. After 9/95	634	RB77WPCC	.012	237	RB77CC	.012			624	RHB81N	235	RTB77WPCC	.012
	636	RB77WPC		643	RB75N								
J616 16-Cyl. Thru 8/95	226	RB76PP	.012	576	RB76N	.012			624	RHB81N	235	RTB77WPCC	.012
JLO - ROCKWELL													
G49, L35, L77, LV298, MM25, MM40	1224	RL85G	.020	874	RL82C	.020	551	RHL79G			556	RTL85G	.020
				811	L82C								
GA50 Updated Version, V49	1224	RL85G	.020	874	RL82C	.020	551	RHL79G			556	RTL85G	.020
				811	L82C								
L101, L152, L197				509	D9	.025							
L252, L292, L297, L372				509	D9	.025							
JOHN DEERE													
Gasoline													
92, 115, 145, 165, 217, 232									538	RH8C			.025
									854	RH10C			
LUC, LUH, LUW, LUS									854	RH10C			.025
									844	H10C			
Series TA92, TB92, TA145, TA217									854	RH10C			.025
									844	H10C			
Natural & LP Gas													
300 Series	530	RN79G	.020	123	RN5C	.020	575	RHN79G			1232	RTN79WYP	.020
				120	N5C						540	RTN79G	
341, 400, 500 Series				514	D14	.025							
400, 500 Series Natural & LP Gas	233	RM82WPCC	.012	519	RM77N	.015	236	RHM78WPCC	596	RHM77N	223	RTM77PP	.015
	217	RM77PP					222	RHM78PP	596	RHM77N	1201	RTM78N	
6068NG													
6076AFN30 (150 & 200 h.p.)	1206	RC78WP	.015	1209	RC78YCC15	.015							
	218	RC78PYP											
6081NG													
92, 115, 145, 165, 217, 232									538	RH8C			.025
									854	RH10C			
Stationary Engine Type W, WSP				518	W18	.025							
J-W POWER													
Superburn	228	RW77PP	.015	206	RW77N	.015			577	RHW77N	552	RGC77N	.015
				539	W77N								
Superburn Pre-Cell	530	RN79G	.020	123	RN5C	.020	575	RHN79G			1232	RTN79WYP	.020
				120	N5C						540	RTN79G	
LISTER PETER													



MAKE YEAR and MODEL	PREMIUM LONG LIFE			COPPER PLUS UNSHIELDED			PREMIUM SHIELDED 3/4"-20		SHIELDED 3/4"-20		INTEGRAL COIL TYPE 13/16"-20		
	STOCK NO.	PLUG TYPE	GAP	STOCK NO.	PLUG TYPE	GAP	STOCK NO.	PLUG TYPE	STOCK NO.	PLUG TYPE	STOCK NO.	PLUG TYPE	GAP
LISTER PETER													
Alpha Series LPWG2, 3 & 4 HR2G, HR3G				344	RC9YC	.200							
				506	D6	.015							
				625	D78Y								
LORAIN													
30, 37, 40, 50				516	D16	.025							
				555	UD16								
A, L, O, R 7/8"-18 Heads	1207	RW80PP	.012	545	W85N	.012	1204	RHW80PP	532	RHW80N	638	RTW80N	.012
	582	RW82P											
LUFKIN													
GSC				513	C97B	.025							
				513	C97B								
H1770, H2165 Normal Service	1207	RW80PP	.012	545	W85N	.012	1204	RHW80PP	532	RHW80N	638	RTW80N	.012
	582	RW82P											
H1770, H2165 Severe Service	1207	RW80PP	.012	553	RW80N	.012	1204	RHW80PP	532	RHW80N	638	RTW80N	.012
	582	RW82P		580	W80N								
H795 Severe Service	1207	RW80PP	.012	545	W85N	.012	1204	RHW80PP	532	RHW80N	638	RTW80N	.012
	582	RW82P											
HT333, HC333, H795, GSD, GSDH	1207	RW80PP	.012	510	W10	.015	1204	RHW80PP	532	RHW80N	638	RTW80N	.015
	582	RW82P		545	W85N								
L333, L795, L1770, L2165, F280				589	W89D	.025							
M.E.P. INDUSTRIES													
M.E.P.-6, -8, -10, -12	233	RM82WPCC	.012	519	RM77N	.015	236	RHM78WPCC	234	RHM78N	223	RTM77PP	.015
	217	RM77PP		566	M82N		222	RHM78PP	583	RHM83N	1201	RTM78N	
MAN NUTZFAHRZEUGE													
E 0824 - E 301, E 302	530	RN79G	.012										
E 0826 - E 301, E 302	530	RN79G	.012										
E 0834	1206	RC78WP	.012	1209	RC78YCC15	.012							
	218	RC78PYP											
E 0836	1206	RC78WP	.012	1209	RC78YCC15	.012							
	218	RC78PYP											
E 2482, E 2842 E & LE	530	RN79G	.012										
E 2843 LN	530	RN79G	.012										
E 2866 DUH03	642	RN79G	.200										
	642	RN79G											
E 2866 LUH01	530	RN79G	.012										
E 2876	530	RN79G	.012										
MAYTAG													
Washing Machines													
14mm Heads				592	RJ12C	.030							
				511	J11C								
'Multi-Motor' 1/2"-14 Pipe Heads				525	25	.025							
McCULLOCH													
All Other Models				871	RJ8C	.030							
				841	J8C								
Models 77, 99				102	RJ6C	.030							
				823	J6C								
MINNEAPOLIS - MOLINE													
GASOLINE													
High-Compression													
165-4A, 185-4A, 206-4A				871	RJ8C	.025							
				841	J8C								
403-4A, 605-6A, 1918-4A, 2714-6A	1207	RW80PP	.012	510	W10	.015	1204	RHW80PP	532	RHW80N	638	RTW80N	.015
	582	RW82P		545	W85N								
BEU, DU, FEU, GU, GUA, HU	1207	RW80PP	.012	510	W10	.015	1204	RHW80PP	532	RHW80N	638	RTW80N	.015
	582	RW82P		545	W85N								
CU, KEU, JU, 283-4A, 4256A 18mm Hds.				509	D9	.025							
CU, KEU, JU, 283-4A, 4256A 7/8"-18 Hds.	1207	RW80PP	.012	510	W10	.015	1204	RHW80PP	532	RHW80N	638	RTW80N	.015
	582	RW82P		545	W85N								
LU, MEU, NEU, SEU, TAU, TEU	1207	RW80PP	.012	510	W10	.015	1204	RHW80PP	532	RHW80N	638	RTW80N	.015
	582	RW82P		545	W85N								
Low-Compression													



COMMERCIAL, STATIONARY AND GAS ENGINE APPLICATIONS

MAKE YEAR and MODEL	PREMIUM LONG LIFE			COPPER PLUS UNSHIELDED			PREMIUM SHIELDED 3/4"-20		SHIELDED 3/4"-20		INTEGRAL COIL TYPE 13/16"-20		
	STOCK NO.	PLUG TYPE	GAP	STOCK NO.	PLUG TYPE	GAP	STOCK NO.	PLUG TYPE	STOCK NO.	PLUG TYPE	STOCK NO.	PLUG TYPE	GAP
MINNEAPOLIS - MOLINE													
GASOLINE													
Low-Compression													
165-4A, 185-4A, 206-4A				871	RJ8C	.025							
				841	J8C								
220-4, HD220-4A, M220-A4A				514	D14	.025							
336A-4A, HD425-6A				514	D14	.025							
403-4A, 605-6A 14mm Hds.				868	RJ19LM	.025							
				861	J19LM								
403-4A, 605-6A, 1918-4A, 2714-6A	1207	RW80PP	.012	510	W10	.015	1204	RHW80PP	532	RHW80N	638	RTW80N	.015
	582	RW82P		545	W85N								
800-6A, 1210-12A 14mm Hds.				868	RJ19LM	.025							
				861	J19LM								
All Above Models w/18mm Heads				514	D14	.025							
BEU, DU, FEU, GU, GUA, HU	1207	RW80PP	.012	510	W10	.015	1204	RHW80PP	532	RHW80N	638	RTW80N	.015
	582	RW82P		545	W85N								
CU, KEU, JU, 283-4A, 4256A	1207	RW80PP	.012	510	W10	.015	1204	RHW80PP	532	RHW80N	638	RTW80N	.015
	582	RW82P		545	W85N								
HD504-6A, HD425-6A				514	D14	.025							
HD504A-6A, 605A-6A, 605B-6A				514	D14	.025							
HD605-6A, 800-6A				514	D14	.025							
HD800-6A, HD800A-6A, 1210-12A	233	RM82WPCC	.012	514	D14	.025	236	RHM78WPCC	234	RHM78N	223	RTM77PP	.015
	217	RM77PP		519	RM77N		222	RHM78PP			1201	RTM78N	
LU, MEU, NEU, SEU, TAU, TEU	1207	RW80PP	.012	510	W10	.015	1204	RHW80PP	532	RHW80N	638	RTW80N	.015
	582	RW82P		545	W85N								
NATURAL & LP GAS													
206-4A, 220-4, HD220-4A, M220-A4A	233	RM82WPCC	.012	519	RM77N	.015	236	RHM78WPCC	234	RHM78N	223	RTM77PP	.015
	217	RM77PP					222	RHM78PP			1201	RTM78N	
283-4A, HD504-6A	233	RM82WPCC	.012	519	RM77N	.015	236	RHM78WPCC	234	RHM78N	223	RTM77PP	.015
	217	RM77PP					222	RHM78PP			1201	RTM78N	
336A-4A, HD425-6A, HD504A-6A	233	RM82WPCC	.012	519	RM77N	.015	236	RHM78WPCC	234	RHM78N	223	RTM77PP	.015
	217	RM77PP					222	RHM78PP			1201	RTM78N	
403-4A, 605-6A, 1918-4A, 2714-6A	1207	RW80PP	.012	510	W10	.015	1204	RHW80PP	532	RHW80N	638	RTW80N	.015
	582	RW82P		545	W85N								
425-6A	1207	RW80PP	.012	510	W10	.015	1204	RHW80PP	532	RHW80N	638	RTW80N	.015
	582	RW82P		545	W85N								
605A-6A, 605B-6A, HD605-6A	233	RM82WPCC	.012	519	RM77N	.015	236	RHM78WPCC	234	RHM78N	223	RTM77PP	.015
	217	RM77PP					222	RHM78PP			1201	RTM78N	
800-6A, 1210-12A, 1600-12A	1207	RW80PP	.012	510	W10	.015	1204	RHW80PP	532	RHW80N	638	RTW80N	.015
	582	RW82P		545	W85N								
BEU, DU, FEU, GU, GUA, HU	1207	RW80PP	.012	510	W10	.015	1204	RHW80PP	532	RHW80N	638	RTW80N	.015
	582	RW82P		545	W85N								
CU, KEU, JU, 283-4A, 4256A	1207	RW80PP	.012	510	W10	.015	1204	RHW80PP	532	RHW80N	638	RTW80N	.015
	582	RW82P		545	W85N								
HD800-6A, HD800A-6A, 1210-12A	233	RM82WPCC	.012	519	RM77N	.025	236	RHM78WPCC	234	RHM78N	223	RTM77PP	.015
	217	RM77PP					222	RHM78PP			1201	RTM78N	
LU, MEU, NEU, SEU, TAU, TEU	1207	RW80PP	.012	510	W10	.015	1204	RHW80PP	532	RHW80N	638	RTW80N	.015
	582	RW82P		545	W85N								
NORDBERG (HATCH & KIRK)													
4FG Shielded Ignition w/ Pulse Generator									624	RHB81N	235	RTB77WPCC	.012
4FG Unshielded Ignition				542	B86N	.012							
FSE96 Natural Gas	226	RB76PP	.012	576	RB76N	.012			624	RHB81N	235	RTB77WPCC	.012
Power Chief 4FG				514	D14	.025							
RTG Series Natural Gas				542	B86N	.012			624	RHB81N	235	RTB77WPCC	.012
O.M.C.													
Single And Twin Cylinder				22	RF11YC	.030							
OILWELL													
1/2"-14 Pipe Heads				525	25	.025							
18mm Heads				597	K97F	.025							
OLIN													
All Models OLIN				525	25	.025							
PERKINS													
	1230	FB77WPCC											



MAKE YEAR and MODEL	PREMIUM LONG LIFE			COPPER PLUS UNSHIELDED			PREMIUM SHIELDED 3/4"-20		SHIELDED 3/4"-20		INTEGRAL COIL TYPE 13/16"-20		
	STOCK NO.	PLUG TYPE	GAP	STOCK NO.	PLUG TYPE	GAP	STOCK NO.	PLUG TYPE	STOCK NO.	PLUG TYPE	STOCK NO.	PLUG TYPE	GAP
PERKINS													
4000 Series	634	RB77WPCC	.012										
	636	RB77WPC											
900 Series	244	RC78PYP21	.021										
G4-203				322	RN11YC4	.025							
				302	N11YC								
G4-236				404	RN12YC	.025							
				38	N12YC								
RATHBUN JONES													
All Models RATHBUN JONES				597	K97F	.020							
Models w/G-402 Reducing Bushing	233	RM82WPCC	.012	519	RM77N	.015	236	RHM78WPCC	234	RHM78N	223	RTM77PP	.015
	217	RM77PP		529	D14N		222	RHM78PP			1201	RTM78N	
ROBIN (See Fuji-Robin)													
ROILINE													
ENGINES w/INTEGRAL COIL													
F1500, H2000, H2470 (Heavy Load)	233	RM82WPCC	.012	519	RM77N	.015	236	RHM78WPCC	234	RHM78N	223	RTM77PP	.015
	217	RM77PP					222	RHM78PP			1201	RTM78N	
F1500, H2000, H2470 (Light Load)	233	RM82WPCC	.012	571	RM79F	.015	236	RHM78WPCC	234	RHM78N	223	RTM77PP	.015
	217	RM77PP					222	RHM78PP			1201	RTM78N	
H540, H844, H570, H884	233	RM82WPCC	.012	571	RM79F	.015	236	RHM78WPCC	234	RHM78N	223	RTM77PP	.015
	217	RM77PP					222	RHM78PP			1201	RTM78N	
L3230, L3460, L4000 (Heavy Load)	233	RM82WPCC	.012	519	RM77N	.015	236	RHM78WPCC	234	RHM78N	223	RTM77PP	.015
	217	RM77PP					222	RHM78PP			1201	RTM78N	
L3230, L3460, L4000 (Light Load)	233	RM82WPCC	.012	571	RM79F	.015	236	RHM78WPCC	234	RHM78N	223	RTM77PP	.015
	217	RM77PP					222	RHM78PP			1201	RTM78N	
GASOLINE													
A114, A288				592	RJ12C	.030							
				511	J11C								
H540, H844, H884				102	RJ6C	.030							
				823	J6C								
TH884, H570, TH570				102	RJ6C	.030							
				823	J6C								
High Compression Engines													
F1500, F1850, H2000, H2150, H2470	233	RM82WPCC	.012	519	RM77N	.025	236	RHM78WPCC	234	RHM78N	223	RTM77PP	.015
	217	RM77PP					222	RHM78PP	550	ED14	1201	RTM78N	
L3000, L3230, L3460, L4000	233	RM82WPCC	.012	519	RM77N	.025	236	RHM78WPCC	234	RHM78N	223	RTM77PP	.015
	217	RM77PP					222	RHM78PP	572	XED14	1201	RTM78N	
Low Compression Engines													
F1500, F1850, H2000, H2150, H2470	233	RM82WPCC	.012	519	RM77N	.025	236	RHM78WPCC	234	RHM78N	223	RTM77PP	.015
	217	RM77PP					222	RHM78PP	550	ED14	1201	RTM78N	
L3000, L3230, L3460, L4000	233	RM82WPCC	.012	519	RM77N	.025	236	RHM78WPCC	234	RHM78N	223	RTM77PP	.015
	217	RM77PP					222	RHM78PP	572	XED14	1201	RTM78N	
NATURAL & LP GAS													
H540, H570, TH570, H884, TH884				825	J4C	.015							
ROLLS ROYCE													
B Gas													
KV-G4													
K Gas													
KV-G4													
ROPER													
Model 1900, CA301AR				851	DJ6J	.025							
Model 3700				849	CJ6	.025							
ROTAX													
300cc Normal Service				509	D9	.025							
370cc Normal Service	1224	RL85G	.020	830	RL86C	.020	551	RHL79G			556	RTL85G	.020
				306	L86C								
370cc Severe Service	1224	RL85G	.020	874	RL82C	.020	551	RHL79G			556	RTL85G	.020
				811	L82C								
RUSTON													
RK270GS Series	1207	RW80PP	.012	553	RW80N	.012	1204	RHW80PP	532	RHW80N	638	RTW80N	.012
	582	RW82P		580	W80N								
SACHS													



COMMERCIAL, STATIONARY AND GAS ENGINE APPLICATIONS

MAKE YEAR and MODEL	PREMIUM LONG LIFE			COPPER PLUS UNSHIELDED			PREMIUM SHIELDED 3/4"-20		SHIELDED 3/4"-20		INTEGRAL COIL TYPE 13/16"-20		GAP
	STOCK NO.	PLUG TYPE	GAP	STOCK NO.	PLUG TYPE	GAP	STOCK NO.	PLUG TYPE	STOCK NO.	PLUG TYPE	STOCK NO.	PLUG TYPE	
SACHS													
504 Series, 505 Series, 508	1224	RL85G	.025	830	RL86C	.025	551	RHL79G			556	RTL85G	.025
Stamo 277, 281, 293				306	L86C								
Stamo SL-2	1224	RL85G	.025	509	D9	.025							
				874	RL82C	.025	551	RHL79G			556	RTL85G	.025
				811	L82C								
SACM													
Model 175 1996 & up	1206	RC78WP	.015	1209	RC78YCC15	.015							
	218	RC78PYP											
Model UD30 Thru 1994	1206	RC78WP	.015	1209	RC78YCC15	.015							
	218	RC78PYP											
SOLAR TURBINE													
Mars, Centaur									550	ED14			.025
									572	XED14			
Sparton (Igniter)	627	F-6A-13											
	627	F-6A-13											
Type H, Tauros									550	ED14			.025
									572	XED14			
STOVER													
1/2"-14 Pipe Heads				525	25	.025							
CT-1, -2, -3, -4				518	W18	.025							
DV1, DV2, DVA2, XVH, 502 14mm Hds.									587	H8C			.025
									587	H8C			
DV1, DV2, DVA2, XVH, 502 7/8"-18 Hds.				518	W18	.025							
DVA, DVA1				514	D14	.025							
K-1, K-6, K-8, MV-2, MV-5, MV-6, MV-7				518	W18	.025							
MVA, IXA				569	W14	.030							
STRUCK													
Mini-Dozer				871	RJ8C	.030							
				841	J8C								
SUPERIOR													
1706G2, 1712G1	1230	FB77WPCC											
	634	RB77WPCC	.012	237	RB77CC	.012			624	RHB81N	235	RTB77WPCC	.012
	636	RB77WPC		643	RB75N								
1965-58 GX825 Series	233	RM82WPCC	.012	519	RM77N	.015	236	RHM78WPCC			223	RTM77PP	.015
	217	RM77PP		529	D14N		222	RHM78PP			1201	RTM78N	
1970-63 VG825 Series*86	1207	RW80PP	.012	553	RW80N	.012	1204	RHW80PP	532	RHW80N	638	RTW80N	.012
	582	RW82P		580	W80N								
1970-63 VGT825 Series*86	1207	RW80PP	.012	553	RW80N	.012	1204	RHW80PP	532	RHW80N	638	RTW80N	.012
	582	RW82P		580	W80N								
1973-39 80G Series				514	D14	.025			572	XED14			.025
1973-39 80GX Series				514	D14	.025			572	XED14			.025
1979-65 GT825 Series	233	RM82WPCC	.012	519	RM77N	.015	236	RHM78WPCC	234	RHM78N	223	RTM77PP	.015
	217	RM77PP		529	D14N		222	RHM78PP			1201	RTM78N	
1980-46 G510 Series	233	RM82WPCC	.012	519	RM77N	.015	236	RHM78WPCC	234	RHM78N	223	RTM77PP	.015
	217	RM77PP		529	D14N		222	RHM78PP			1201	RTM78N	
1980-51 G825 Series	233	RM82WPCC	.012	519	RM77N	.015	236	RHM78WPCC	234	RHM78N	223	RTM77PP	.015
	217	RM77PP		529	D14N		222	RHM78PP			1201	RTM78N	
1980-61 GT510 Series	233	RM82WPCC	.012	519	RM77N	.015	236	RHM78WPCC			223	RTM77PP	.015
	217	RM77PP		529	D14N		222	RHM78PP			1201	RTM78N	
1980-76 SGT Series	233	RM82WPCC	.012	519	RM77N	.015	236	RHM78WPCC			223	RTM77PP	.015
	217	RM77PP		529	D14N		222	RHM78PP			1201	RTM78N	
1980-79 GTL Series	233	RM82WPCC	.012	519	RM77N	.015	236	RHM78WPCC	234	RHM78N	223	RTM77PP	.015
	217	RM77PP		529	D14N		222	RHM78PP			1201	RTM78N	
1991-81 GTLA/B Series				625	D78Y	.015							
1991-81 GTLA/B Series (Light Use)				526	RD15Y	.015							
				515	D15Y								
1991-81 SGT/A/B Series				625	D78Y	.015							
1991-81 SGT/A/B Series (Light Use)				526	RD15Y	.015							
				515	D15Y								
2400 G Series				643	RB75N	.012							
TELEDYNE (See Continental or Wisconsin)													
TRANSAMERICA DELAVAL (See Delaval)													



MAKE YEAR and MODEL	PREMIUM LONG LIFE			COPPER PLUS UNSHIELDED			PREMIUM SHIELDED 3/4"-20		SHIELDED 3/4"-20		INTEGRAL COIL TYPE 13/16"-20		
	STOCK NO.	PLUG TYPE	GAP	STOCK NO.	PLUG TYPE	GAP	STOCK NO.	PLUG TYPE	STOCK NO.	PLUG TYPE	STOCK NO.	PLUG TYPE	GAP
UNIVERSAL													
18mm Heads				514	D14	.025							
7/8"-18 Heads				569	W14	.030							
Atomic Four				871	RJ8C	.030							
				841	J8C								
VOLKSWAGEN													
ADF, ADH w/1.8L Eng.				415	RN9YC	.035							
				300	N9YC								
EA111 w/1.0L Eng.				415	RN9YC	.035							
				300	N9YC								
Models 122, 124A Gasoline	1224	RL85G	.025	830	RL86C	.025	551	RHL79G			556	RTL85G	.025
				306	L86C								
Models 122, 124A Natural & LPG	1224	RL85G	.025	874	RL82C	.025	551	RHL79G			556	RTL85G	.025
				811	L82C								
WARTSILA													
Model 175 After 1994	1206	RC78WP	.015	1209	RC78YCC15								
	218	RC78PYP											
	1230	FB77WPCC											
Model 34SG													
	1230	FB77WPCC											
Model W20V													
	1230	FB77WPCC											
Model W25SG, W28SG, W34SG	634	RB77WPCC	.012	237	RB77CC	.012			624	RHB81N	235	RTB7WPCC	.012
	636	RB77WPC		643	RB75N								
WAUKESHA													
AT SERIES													
Inline-8													
8L-AT25GL/AT27GL (1/2" Reach Heads)	233	RM82WPCC	.012	640	RM77N	.012	236	RHM78WPCC	234	RHM78N	223	RTM77PP	.012
	217	RM77PP					222	RHM78PP			1201	RTM78N	
	1230	FB77WPCC											
8L-AT25GL/AT27GL (13/16" Reach Heads)	634	RB77WPCC	.012	237	RB77CC	.012			624	RHB81N	235	RTB7WPCC	.012
	636	RB77WPC		643	RB75N								
V-12													
12V-AT25GL/AT27GL (1/2" Reach Heads)	233	RM82WPCC	.012	640	RM77N	.012	236	RHM78WPCC	234	RHM78N	223	RTM77PP	.012
	217	RM77PP					222	RHM78PP			1201	RTM78N	
	1230	FB77WPCC											
12V-AT25GL/AT27GL (13/16" Reach Heads)	634	RB77WPCC	.012	237	RB77CC	.012			624	RHB81N	235	RTB7WPCC	.012
	636	RB77WPC		643	RB75N								
GASOLINE													
14mm Heads													
135G, 135GK, 135GKB, 135GZB									538	RH8C			.025
									587	H8C			
135GZ, 140GZ, 145GZ, F554G, F817G				871	RJ8C	.030			557	XEJ8			.025
				841	J8C				557	XEJ8			
140G, 140GK, 140GKB, 140GZB									538	RH8C			.025
									587	H8C			
145G, 145GK, 145GKB, 145GZB									538	RH8C			.025
									587	H8C			
Cranes, Carriers, Power Shovels				871	RJ8C	.030			557	XEJ8			.025
				841	J8C				557	XEJ8			
F265GA, F283G, VRG265				322	RN11YC4	.025							
				302	N11YC								
FC, ICK, 6BZ, 6MZA, 6SRKR, 6WAK				871	RJ8C	.030			557	XEJ8			.025
				841	J8C				557	XEJ8			
Generator Sets				871	RJ8C	.030			557	XEJ8			.025
				841	J8C				557	XEJ8			
H540, H570, H844, H884, H884G				102	RJ6C	.025							
				823	J6C								
VRG220, VRG330	530	RN79G	.015	404	RN12YC	.025	575	RHN79G			1232	RTN79WYP	.015
				38	N12YC						540	RTN79G	
VRG283, VRG310				322	RN11YC4	.025							
				302	N11YC								
18mm Heads													



MAKE YEAR and MODEL	PREMIUM LONG LIFE			COPPER PLUS UNSHIELDED			PREMIUM SHIELDED 3/4"-20		SHIELDED 3/4"-20		INTEGRAL COIL TYPE 13/16"-20		GAP
	STOCK NO.	PLUG TYPE	GAP	STOCK NO.	PLUG TYPE	GAP	STOCK NO.	PLUG TYPE	STOCK NO.	PLUG TYPE	STOCK NO.	PLUG TYPE	
WAUKESHA													
GASOLINE													
18mm Heads													
140GK, 140GS, 145GK, 145GS				516	D16	.025							
				555	UD16								
180G, 180GB, 180GL				514	D14	.025							
180GS, 185GS, 190GS, FC				516	D16	.025							
				555	UD16								
185GL, 185GLB, 190G, 190GL, 190GLB				514	D14	.025							
195G, 195GK, 195GKA, 195GL				514	D14	.025							
6BZ, LRORB, VLRORB, ICK				514	D14	.025							
6LRZ, 6LRZB, 6MZA, 6MZR, 6NK				514	D14	.025							
6NKR, 6NKR, 6SRKR, 6WAK, 6WAKB				514	D14	.025							
CFR				516	D16	.025							
				555	UD16								
D155G, D176G, VRG232				516	D16	.025							
				563	XED16								
F1197GR, VRG155				514	D14	.025							
				572	XED14								
7/8"-18 Heads													
6LRO, 6SRKR, LRORB, XAH				569	W14	.030							
INTERMEDIATE SERIES													
F1197G				514	D14	.025							
F1950GR	233	RM82WPCC	.012	519	RM77N	.015	236	RHM78WPCC	234	RHM78N	223	RTM77PP	.015
	217	RM77PP		566	M82N		222	RHM78PP			1201	RTM78N	
18mm Heads													
140GK, 145GK, FC	233	RM82WPCC	.012	519	RM77N	.015	236	RHM78WPCC	234	RHM78N	223	RTM77PP	.015
	217	RM77PP		529	D14N		222	RHM78PP			1201	RTM78N	
180G, 180GB, 180GKB, 185GLB	233	RM82WPCC	.012	519	RM77N	.015	236	RHM78WPCC	234	RHM78N	223	RTM77PP	.015
	217	RM77PP		529	D14N		222	RHM78PP			1201	RTM78N	
190G, 190GLB, 196G, 195GK	233	RM82WPCC	.012	519	RM77N	.015	236	RHM78WPCC	234	RHM78N	223	RTM77PP	.015
	217	RM77PP		529	D14N		222	RHM78PP			1201	RTM78N	
6BZ, 6LRZ, 6LRZB, 6MZA, 6MZR, ICK	233	RM82WPCC	.012	519	RM77N	.015	236	RHM78WPCC	234	RHM78N	223	RTM77PP	.015
	217	RM77PP		529	D14N		222	RHM78PP			1201	RTM78N	
6NK, 6WAK, 6WAKB, NKR, WAKR, LRORB	233	RM82WPCC	.012	519	RM77N	.015	236	RHM78WPCC	234	RHM78N	223	RTM77PP	.015
	217	RM77PP		529	D14N		222	RHM78PP			1201	RTM78N	
F1197GRSI, F1905GRSI, Generator Set	233	RM82WPCC	.012	519	RM77N	.015	236	RHM78WPCC	234	RHM78N	223	RTM77PP	.015
	217	RM77PP		519	RM77N		222	RHM78PP			1201	RTM78N	
F1850G, H2475G, L3711G LPG				509	D9	.025							
F1850G, H2475G, L3711G Natural Gas				514	D14	.025							
F2894G, F2894GRSI, F3520G, L5100GR	233	RM82WPCC	.012	519	RM77N	.015	236	RHM78WPCC	234	RHM78N	223	RTM77PP	.015
	217	RM77PP		566	M82N		222	RHM78PP			1201	RTM78N	
H1077G, H1077GSI, L1616G, L1616GSI	530	RN79G	.015	509	D9	.025	575	RHN79G			1232	RTN79WYP	.015
											540	RTN79G	
L5100GRSI, L5788GR	233	RM82WPCC	.012	519	RM77N	.015	236	RHM78WPCC	234	RHM78N	223	RTM77PP	.015
	217	RM77PP		566	M82N		222	RHM78PP			1201	RTM78N	
L5788GRSI, L7040G	233	RM82WPCC	.012	519	RM77N	.015	236	RHM78WPCC	234	RHM78N	223	RTM77PP	.015
	217	RM77PP		566	M82N		222	RHM78PP			1201	RTM78N	
L7042GSIE, F3521GSIE	233	RM82WPCC	.012	519	RM77N	.015	236	RHM78WPCC	234	RHM78N	223	RTM77PP	.015
	217	RM77PP					222	RHM78PP			1201	RTM78N	
VRN232, VRN155				514	D14	.025							
7/8" - 18 HEADS													
6SRKR, XAH, LRORB	1207	RW80PP	.012	510	W10	.015	1204	RHW80PP	532	RHW80N	638	RTW80N	.015
	582	RW82P		545	W85N								
Inline-6													
F817G				102	RJ6C	.030							
				823	J6C								
VSG Series													
F11FG F11GSI/GSID	530	RN79G	.015				575	RHN79G			1232	RTN79WYP	.015
											540	RTN79G	
NATURAL & LP GAS													
14mm Heads													
135G, 140G, 145G				102	RJ6C	.020							
				823	J6C								



MAKE YEAR and MODEL	PREMIUM LONG LIFE			COPPER PLUS UNSHIELDED			PREMIUM SHIELDED 3/4"-20		SHIELDED 3/4"-20		INTEGRAL COIL TYPE 13/16"-20		
	STOCK NO.	PLUG TYPE	GAP	STOCK NO.	PLUG TYPE	GAP	STOCK NO.	PLUG TYPE	STOCK NO.	PLUG TYPE	STOCK NO.	PLUG TYPE	GAP
WAUKESHA													
NATURAL & LP GAS													
14mm Heads													
135GZ, 140GZ, 145GZ				102 823	RJ6C J6C	.020							
H1077G, H1077GSI, L1616G, L1616GSI	530	RN79G	.015				575	RHN79G			1232 540	RTN79WYP RTN79G	.015
ICK, F554G, H884G				102 823	RJ6C J6C	.020							
P2154G, P2154GSI	530	RN79G	.015				575	RHN79G			1232 540	RTN79WYP RTN79G	.015
VRG220, VRG330	530	RN79G	.015	123 120	RN5C N5C	.025	575	RHN79G			1232 540	RTN79WYP RTN79G	.015
VRN265, VRN283, VRN310	530	RN79G	.020	123 120	RN5C N5C	.020	575	RHN79G			1232 540	RTN79WYP RTN79G	.020
VGF SERIES													
Inline-6													
F18G, F18GL/GLD	1230 634 636	FB77WPCC RB77WPCC RB77WPC	.012	237 643	RB77CC RB75N	.012			624	RHB81N	235	RTB77WPCC	.012
Inline-8													
H24G, H24GL/GLD	1230 634 636	FB77WPCC RB77WPCC RB77WPC	.012	237 643	RB77CC RB75N	.012			624	RHB81N	235	RTB77WPCC	.012
V-12													
L36GL/GLD	1230 634 636	FB77WPCC RB77WPCC RB77WPC	.012	237 643	RB77CC RB75N	.012			624	RHB81N	235	RTB77WPCC	.012
V-16													
P48GL/GLD	1230 634 636	FB77WPCC RB77WPCC RB77WPC	.012	237 643	RB77CC RB75N	.012			624	RHB81N	235	RTB77WPCC	.012
VHP SERIES													
Inline-6													
2895GL (1/2" Reach Heads)	233 217	RM82WPCC RM77PP	.012	640	RM77N	.012	236 222	RHM78WPCC RHM78PP	234	RHM78N	223 1201	RTM77PP RTM78N	.012
2895GL (13/16" Reach Heads)	634 636	RB77WPCC RB77WPC	.012	237 643	RB77CC RB75N	.012			624	RHB81N	235	RTB77WPCC	.012
3521GL (1/2" Reach Heads)	233 217	RM82WPCC RM77PP	.012	640	RM77N	.012	236 222	RHM78WPCC RHM78PP	234	RHM78N	223 1201	RTM77PP RTM78N	.012
3521GL (13/16" Reach Heads)	634 636	RB77WPCC RB77WPC	.012	237 643	RB77CC RB75N	.012			624	RHB81N	235	RTB77WPCC	.012
F2895G, F2895GSI	233 217	RM82WPCC RM77PP	.012	519	RM77N	.015	236 222	RHM78WPCC RHM78PP	234	RHM78N	223 1201	RTM77PP RTM78N	.015
F3521G, F3521GSI	233 217	RM82WPCC RM77PP	.012	519	RM77N	.015	236 222	RHM78WPCC RHM78PP	234	RHM78N	223 1201	RTM77PP RTM78N	.015
V-12													
5108GL (1/2" Reach Heads)	233 217	RM82WPCC RM77PP	.012	640	RM77N	.012	236 222	RHM78WPCC RHM78PP	234	RHM78N	223 1201	RTM77PP RTM78N	.012
5108GL (13/16" Reach Heads)	634 636	RB77WPCC RB77WPC	.012	237 643	RB77CC RB75N	.012			624	RHB81N	235	RTB77WPCC	.012
5790GL (1/2" Reach Heads)	233 217	RM82WPCC RM77PP	.012	640	RM77N	.012	236 222	RHM78WPCC RHM78PP	234	RHM78N	223 1201	RTM77PP RTM78N	.012
5790GL (13/16" Reach Heads)	634 636	RB77WPCC RB77WPC	.012	237 643	RB77CC RB75N	.012			624	RHB81N	235	RTB77WPCC	.012
7042GL (1/2" Reach Heads)	233 217	RM82WPCC RM77PP	.012	640	RM77N	.012	236 222	RHM78WPCC RHM78PP	234	RHM78N	223 1201	RTM77PP RTM78N	.012
7042GL (13/16" Reach Heads)	634 636	RB77WPCC RB77WPC	.012	237 643	RB77CC RB75N	.012			624	RHB81N	235	RTB77WPCC	.012



COMMERCIAL, STATIONARY AND GAS ENGINE APPLICATIONS

MAKE YEAR and MODEL	PREMIUM LONG LIFE			COPPER PLUS UNSHIELDED			PREMIUM SHIELDED 3/4"-20		SHIELDED 3/4"-20		INTEGRAL COIL TYPE 13/16"-20			GAP
	STOCK NO.	PLUG TYPE	GAP	STOCK NO.	PLUG TYPE	GAP	STOCK NO.	PLUG TYPE	STOCK NO.	PLUG TYPE	STOCK NO.	PLUG TYPE	GAP	
WAUKESHA														
VHP SERIES														
V-12														
L5108G, L5108GSI, L5790G	233	RM82WPCC	.012	519	RM77N	.015	236	RHM78WPCC	234	RHM78N	223	RTM77PP	.015	
	217	RM77PP					222	RHM78PP			1201	RTM78N		
L5790GSI, L7042G, L7042GSI	233	RM82WPCC	.012	519	RM77N	.015	236	RHM78WPCC	234	RHM78N	223	RTM77PP	.015	
	217	RM77PP					222	RHM78PP			1201	RTM78N		
V-16														
5115GL	1230	FB77WPCC												
	634	RB77WPCC	.012	237	RB77CC	.012			624	RHB81N	235	RTB77WPCC	.012	
	636	RB77WPC		643	RB75N									
9390G, P9390GSI	233	RM82WPCC	.012	519	RM77N	.015	236	RHM78WPCC	234	RHM78N	223	RTM77PP	.015	
	217	RM77PP					222	RHM78PP			1201	RTM78N		
9390GL (1/2" Reach Heads)	233	RM82WPCC	.012	640	RM77N	.012	236	RHM78WPCC	234	RHM78N	223	RTM77PP	.012	
	217	RM77PP					222	RHM78PP			1201	RTM78N		
9390GL (13/16" Reach Heads)	1230	FB77WPCC												
	634	RB77WPCC	.012	237	RB77CC	.012			624	RHB81N	235	RTB77WPCC	.012	
	636	RB77WPC		643	RB75N									
VSG SERIES														
18mm Heads														
140GK, 145GK, FC	233	RM82WPCC	.012	519	RM77N	.015	236	RHM78WPCC	234	RHM78N	223	RTM77PP	.015	
	217	RM77PP		529	D14N		222	RHM78PP			1201	RTM78N		
180G, 180GB, 180GKB, 185GLB	233	RM82WPCC	.012	519	RM77N	.015	236	RHM78WPCC	234	RHM78N	223	RTM77PP	.015	
	217	RM77PP		529	D14N		222	RHM78PP			1201	RTM78N		
190G, 190GLB, 195G, 195GK	233	RM82WPCC	.012	519	RM77N	.015	236	RHM78WPCC	234	RHM78N	223	RTM77PP	.015	
	217	RM77PP		529	D14N		222	RHM78PP			1201	RTM78N		
6BZ, 6LRZ, 6LRZB, 6MZA, 6MZR, ICK	233	RM82WPCC	.012	519	RM77N	.015	236	RHM78WPCC	234	RHM78N	223	RTM77PP	.015	
	217	RM77PP		529	D14N		222	RHM78PP			1201	RTM78N		
6NK, 6WAK, 6WAKB, NKRB, WAKR, LRORB	233	RM82WPCC	.012	519	RM77N	.015	236	RHM78WPCC	234	RHM78N	223	RTM77PP	.015	
	217	RM77PP		529	D14N		222	RHM78PP			1201	RTM78N		
F1197GRSI, F1905GRSI, Generator Set	233	RM82WPCC	.012	519	RM77N	.015	236	RHM78WPCC	234	RHM78N	223	RTM77PP	.015	
	217	RM77PP					222	RHM78PP			1201	RTM78N		
F1850G, H2475G, L3711G LPG				509	D9	.025								
F1850G, H2475G, L3711G Natural Gas				514	D14	.025								
F2894G, F2894GRSI, F3520G, L5100GR	233	RM82WPCC	.012	519	RM77N	.015	236	RHM78WPCC	234	RHM78N	223	RTM77PP	.015	
	217	RM77PP		566	M82N		222	RHM78PP			1201	RTM78N		
H1077G, H1077GSI, L1616G, L1616GSI	530	RN79G	.015	509	D9	.025	575	RHN79G			1232	RTN79WYP	.015	
											540	RTN79G		
L5100GRSI, L5788GR	233	RM82WPCC	.012	519	RM77N	.015	236	RHM78WPCC	234	RHM78N	223	RTM77PP	.015	
	217	RM77PP		566	M82N		222	RHM78PP			1201	RTM78N		
L5788GRSI, L7040G	233	RM82WPCC	.012	519	RM77N	.015	236	RHM78WPCC	234	RHM78N	223	RTM77PP	.015	
	217	RM77PP		566	M82N		222	RHM78PP			1201	RTM78N		
L7042GSIE, F3521GSIE	233	RM82WPCC	.012	519	RM77N	.015	236	RHM78WPCC	234	RHM78N	223	RTM77PP	.015	
	217	RM77PP					222	RHM78PP			1201	RTM78N		
VRN232, VRN155				514	D14	.025								
Inline-6														
F11G, F11GSI/GSID	530	RN79G	.015				575	RHN79G			1232	RTN79WYP	.015	
											540	RTN79G		
WEST BEND														
All Other Models (Light Load)									854	RH10C			.025	
									844	H10C				
All Other Models (Normal Load)									538	RH8C			.025	
									587	H8C				
All Other Models (Severe Load)				102	RJ6C	.030								
				823	J6C									
Models 610, 820				874	RL82C	.030								
				811	L82C									
WHITE ENGINES, INC. (See Hercules)														
WHITE-SUPERIOR (See Superior)														
WISCONSIN														
ACN, AEN, AENLD				516	D16	.030								
				564	D16J									
AEH, AENL, AENS, AFH, AGH, AHH				516	D16	.030								
				564	D16J									



MAKE YEAR and MODEL	PREMIUM LONG LIFE			COPPER PLUS UNSHIELDED			PREMIUM SHIELDED 3/4"-20		SHIELDED 3/4"-20		INTEGRAL COIL TYPE 13/16"-20		
	STOCK NO.	PLUG TYPE	GAP	STOCK NO.	PLUG TYPE	GAP	STOCK NO.	PLUG TYPE	STOCK NO.	PLUG TYPE	STOCK NO.	PLUG TYPE	GAP
WISCONSIN													
AGND				502	D21	.025							
All 18mm Heads Using LP Gas				509	D9	.025							
BKN, S7D, S8D, S10D, S12D, S14D, TE				516	D16	.030							
				564	D16J								
TF, TH, THD, TRA10D, TRA12D, THPD, TJD				516	D16	.030							
				564	D16J								
THOM, VE4, VF4, VE4, VF4D				516	D16	.030							
				564	D16J								
V460D, V461D, V465D				404	RN12YC	.025							
				38	N12YC								
VG4D, VH4, VH4D, W2-280				516	D16	.030							
				564	D16J								
VH4DM, TR10D, W4-1770, W2-1230				516	D16	.030							
				564	D16J								
W2-1230 Serial #5996538 & Up	530	RN79G	.020	123	RN5C	.020	575	RHN79G			1232	RTN79WYP	.020
				120	N5C						540	RTN79G	
W2-1235, W4-2460, W2-1250	530	RN79G	.020	123	RN5C	.020	575	RHN79G			1232	RTN79WYP	.020
				120	N5C						540	RTN79G	
W2-880, W2-1230 Thru Serial #5995537				516	D16	.030							
				564	D16J								
WISCONSIN-ROBIN													
EY18-3W, EY25W Gasoline	1224	RL85G	.025	830	RL86C	.025	551	RHL79G			556	RTL85G	.025
				306	L86C								
EY18-3W, EY25W Kerosene				806	L92YC	.025							
EY18W, EY21W, EY27W, EY44W	1224	RL85G	.025	830	RL86C	.025	551	RHL79G			556	RTL85G	.025
				306	L86C								
W1-080, W1-150, W1-230, W1-280				327	RL87YC	.025							
				312	L87YC								
W1-145, W1-390, W1-185, W1-340	1224	RL85G	.025	830	RL86C	.025	551	RHL79G			556	RTL85G	.025
				306	L86C								
WT-125V, W1-450V	1224	RL85G	.025	830	RL86C	.025	551	RHL79G			556	RTL85G	.025
				306	L86C								
WITTE (See Oilwell)													
G-260	1224	RL85G	.015	874	RL82C	.015	551	RHL79G			556	RTL85G	.015
				811	L82C								
WORTHINGTON													
AG, BG, BBG, EEGX				569	W14	.030							
CG, CCG, CCGX, DG, DDG	1207	RW80PP	.012	545	W85N	.012	1204	RHW80PP	532	RHW80N	638	RTW80N	.012
	582	RW82P											
DDGX Gasoline				102	RJ6C	.030							
				823	J6C								
DDGX Natural Gas				825	J4C	.015							
DHG, DRG, EEG	1207	RW80PP	.012	545	W85N	.012	1204	RHW80PP	532	RHW80N	638	RTW80N	.012
	582	RW82P											
EHG, LFC, LCE	1207	RW80PP	.012	545	W85N	.012	1204	RHW80PP	532	RHW80N	638	RTW80N	.012
	582	RW82P											
LTC 18X25, & LTC 20X25				518	W18	.025							
ML Turbocharged	1207	RW80PP	.012	553	RW80N	.012	1204	RHW80PP	532	RHW80N	638	RTW80N	.012
	582	RW82P		580	W80N								
SDHG & SDHP Severe Service	1207	RW80PP	.012	553	RW80N	.012	1204	RHW80PP	532	RHW80N	638	RTW80N	.012
	582	RW82P		580	W80N								
SLHC, SLHCA, SLHP	1207	RW80PP	.012	553	RW80N	.012	1204	RHW80PP	532	RHW80N	638	RTW80N	.012
	582	RW82P		580	W80N								
SUTC, SEGH, SWG	1207	RW80PP	.012	553	RW80N	.012	1204	RHW80PP	532	RHW80N	638	RTW80N	.012
	582	RW82P		580	W80N								
SWG, SOME, SEHG w/Clamp in plugs				598	RS79N	.012							
UTC	1207	RW80PP	.012	553	RW80N	.012	1204	RHW80PP	532	RHW80N	638	RTW80N	.012
	582	RW82P		580	W80N								
UTC Shielded							578	REW82P	534	REW80N			.012
YAMAHA													
AS110	1224	RL85G	.025	830	RL86C	.025	551	RHL79G			556	RTL85G	.025
				306	L86C								
MF180, MF260, MF410				327	RL87YC	.025							
				312	L87YC								



COMMERCIAL, STATIONARY AND GAS ENGINE APPLICATIONS

MAKE YEAR and MODEL	PREMIUM LONG LIFE			COPPER PLUS UNSHIELDED			PREMIUM SHIELDED 3/4"-20		SHIELDED 3/4"-20		INTEGRAL COIL TYPE 13/16"-20		GAP
	STOCK NO.	PLUG TYPE	GAP	STOCK NO.	PLUG TYPE	GAP	STOCK NO.	PLUG TYPE	STOCK NO.	PLUG TYPE	STOCK NO.	PLUG TYPE	
Yanmar													
Y12, Y18, Y24, Y33				405	RN14YC	.030							
YOUNG													
All Models YOUNG				518	W18	.025							



MAKE YEAR AND MODEL	SHIELDED 5/8"-24			MAKE YEAR AND MODEL	SHIELDED 5/8"-24		
	STOCK NO.	PLUG TYPE	GAP		STOCK NO.	PLUG TYPE	GAP
BUDA (see Allis-Chalmers)				COOPER - BESSEMER			
				G402 REDUCING BUSHING			
				GDJ, GMA, GMB, GMC	568	REM77N	0.015
				GDT, GFB, GFE, GFK	568	REM77N	0.015
CASE				COOPER ENERGY SERVICES (see Superior)			
GASOLINE							
188G, 301G, 377G	563	XED16	0.025				
A284, A377, 159G	563	XED16	0.025				
NATURAL & LP GAS							
188G, 301G, 377G	568	REM77N	0.012				
A284, A377, 159G	568	REM77N	0.012				
CATERPILLAR				CP - CHICAGO PNEUMATIC			
STARTING ENGINE FOR DIESELS							
D320, D326, D337 18mm Heads	563	XED16	0.025	9CPG High Compression	534	REW80N	0.012
D339, D342, D343, D353 18mm Heads	563	XED16	0.025	9CPG Low Compression	563	XED16	0.025
D375, D379, D397, D398 18mm Heads	563	XED16	0.025				
CLARK (see Dresser Clark)				DECO-GRAND			
				AU7B, DE8	567	XEJ12	0.025
CLEVELAND DIESEL				DORMAN			
Model 358	578	REW82P	0.012	12S, 12STCWG, 12STCAG, 6PG, 12PG	568	REM77N	0.015
				12SG	568	REM77N	0.015
				6PG, 12PG	568	REM77N	0.015
CLIMAX				DRESSER CLARK			
GASOLINE							
CE101, CE106, CE264 Normal Service	568	REM77N	0.012	BA, HBA, HMA, HLA, HRA, MA	578	REW82P	0.012
CE46, CE66, CE81, CE96 Normal Service	550	ED14	0.025	RA, TRA, TLA, TCV	578	REW82P	0.012
CE46, CE66, CE81, CE96 Normal Service	572	XED14	0.025	SUPER & TURBOCHARGED			
R-165 Snowplow Only Normal Service	563	XED16	0.025	HBAT, HLAT, HRAT, TRA, TLA	578	REW82P	0.012
V-80, V-85, V-122, V-125 8.2:1 C.R. Normal Service	550	ED14	0.015	TCVB, TCVC, TVM, VMC	578	REW82P	0.012
V-80, V-85, V-122, V-125 8.2:1 C.R. Normal Service	572	XED14	0.015	TLAB, TLAC, TLAD, TPV, TCVA	578	REW82P	0.012
V-80, V-85, V-122, V-125 9.4:1 C.R. Normal Service	568	REM77N	0.012	TVC, HSRA, RAS, TMB	578	REW82P	0.012
CONTINENTAL				DRESSER RAND			
NATURAL & LP GAS							
C46, C66, C96, C106, C255	505	ED89D	0.025	TCV, TCVA, TCVD, TLAD	578	REW82P	0.012
NORMAL SERVICE				ENTERPRISE			
B405, 4124, 4140, 4162, 4163, 6226	563	XED16	0.025	7/8" - 18 HEADS			
B6244, 6245, 6277, 6371, 6405, 6427	563	XED16	0.025	GSM-36, 38	578	REW82P	0.012
C46, C66	563	XED16	0.025	CENTER OF HEAD			
E223, F124, 135, 140, 162, 163, 186	563	XED16	0.025	TDSG-36-6-38	578	REW82P	0.012
F209, 226, 227, 244, 245	563	XED16	0.025	FAIRBANKS MORSE			
G134, 157, 176, H227, 243, 260	563	XED16	0.025	38D8-1 SERIES	568	REM77N	0.012
J382 TO 403, T371 TO 247	563	XED16	0.025	FICHTEL-SACH (see Sachs)			
M6271, 6290, 6330, 6363, OS220	563	XED16	0.025				
R6513, 6572, 6602, U6501 18mm Heads	563	XED16	0.025	GENERAL MOTORS			
RS542, T6371, 6427, TC56	563	XED16	0.025	16-358HN, 16-358-X	578	REW82P	0.012
Y69, Y91, Y112, Y4069, 4091, 4112	563	XED16	0.025	HALL SCOTT			
Z105 TO 120, ZA120	563	XED16	0.025	GASOLINE			
COOPER - BESSEMER							
ENG, GNG	568	REM77N	0.015	1091-OS Intake	563	XED16	0.025
GAW, GMR, GMV, JS	578	REW82P	0.012	136, 180, 190, 504 Exhaust	550	ED14	0.025
GS	563	XED16	0.025	136, 180, 190, 504 Exhaust	572	XED14	0.025
5/8" REACH							
GMW, GMX, V-250, V-275, W330	578	REW82P	0.012	200-0, 201-0, 400-0 Regular	550	ED14	0.025
GMWC, GMWA	578	REW82P	0.012	200-0, 201-0, 400-0 Regular	572	XED14	0.025
GMXE, GMWA, GMXH, W330	578	REW82P	0.012	400-0, 470, 480, 6156 Exhaust	550	ED14	0.025
Z330	578	REW82P	0.012	400-0, 470, 480, 6156 Exhaust	572	XED14	0.025
				440, 2269-0, 1091-OS Exhaust	550	ED14	0.025



COMMERCIAL, STATIONARY AND GAS ENGINE APPLICATIONS-5/8"-24 SHIELDED

MAKE YEAR AND MODEL	SHIELDED 5/8"-24			MAKE YEAR AND MODEL	SHIELDED 5/8"-24		
	STOCK NO.	PLUG TYPE	GAP		STOCK NO.	PLUG TYPE	GAP
HALL SCOTT				MINNEAPOLIS - MOLINE			
440, 2269-0, 1091-OS Exhaust	572	XED14	0.025	GASOLINE			
6156-B1, 6182-B1 Intake	572	XED14	0.025	165-4A, 185-4A, 206-4A Low Comperssion	563	XED16	0.025
6156-B1, 6182-B1 Intake	550	ED14	0.025	220-4, HD220-4A, M220-A4A Low Comperssion	550	ED14	0.025
779-GHI	563	XED16	0.025	220-4, HD220-4A, M220-A4A Low Comperssion	572	XED14	0.025
F3, G1, G2, 6182 Exhaust	550	ED14	0.025	336A-4A, HD425-6A Low Comperssion	550	ED14	0.025
F3, G1, G2, 6182 Exhaust	572	XED14	0.025	336A-4A, HD425-6A Low Comperssion	572	XED14	0.025
G1, G2, FE, 1091G1 Exhaust	550	ED14	0.025	ALL ABOVE MODELS W/18mm HEADS Low Comperssion	572	XED14	0.025
G1, G2, FE, 1091G1 Exhaust	572	XED14	0.025	ALL ABOVE MODELS W/18mm HEADS Low Comperssion	550	ED14	0.025
NATURAL & LP GAS				HD504-6A, HD425-6A Low Comperssion	550	ED14	0.025
400-0, 470, 480, 855, 935 Intake	550	ED14	0.025	HD504-6A, HD425-6A Low Comperssion	572	XED14	0.025
400-0, 470, 480, 855, 935 Intake	572	XED14	0.025	HD504A-6A, 605A-6A, 605B-6A Low Comperssion	550	ED14	0.025
HERCULES				HD504A-6A, 605A-6A, 605B-6A Low Comperssion	572	XED14	0.025
1091-OS Exhaust	550	ED14	0.025	HD504A-6A, 605A-6A, 605B-6A Low Comperssion	572	XED14	0.025
1091-OS Exhaust	572	XED14	0.025	HD605-6A, 800-6A Low Comperssion	572	XED14	0.025
1091-OS Intake	563	XED16	0.025	HD605-6A, 800-6A Low Comperssion	550	ED14	0.025
HXE, HXLEF	563	XED16	0.025	HD800-6A, HD800A-6A, 1210-12A Low Comperssion	550	ED14	0.025
NATURAL & LP GAS				HD800-6A, HD800A-6A, 1210-12A Low Comperssion	572	XED14	0.025
6156, 6182 Gas Intake	550	ED14	0.025	NATURAL & LP GAS			
6156, 6182 Gas Intake	572	XED14	0.025	206-4A, 220-4, HD220-4A, M220-A4A	568	REM77N	0.025
HOPE (see Cooper-Bessemer)				283-4A, HD504-6A	568	REM77N	0.025
				336A-4A, HD425-6A, HD504A-6A	568	REM77N	0.025
				605A-6A, 605B-6A, HD605-6A	568	REM77N	0.025
				HD800-6A, HD800A-6A, 1210-12A	568	REM77N	0.025
INGERSOLL-RAND				NORDBERG (Hatch & Kirk)			
NATURALLY ASPIRATED				Power Chief 4FG	572	XED14	0.025
PKVG, KVGR, PKVGR	578	REW82P	0.012	Power Chief 4FG	550	ED14	0.025
Turbicharged Models	578	REW82P	0.012	RATHBUN JONES			
XVG, PVG, JVG, SVG, KVG, PJVG, PSVG	578	REW82P	0.012	Models w/G402 Reducing Bushing	568	REM77N	0.015
INTERNATIONAL				ROBIN (see Fuji-Robin)			
GASOLINE				ROILINE			
U164, U169, U175 NORMAL SERVICE	563	XED16	0.025	F1500, H2000, H2470 (Light Load)	568	REM77N	0.012
U2, U2A, UC60, UC135 NORMAL SERVICE	563	XED16	0.025	H540, H844, H570, H884	568	REM77N	0.012
UC135B, UC153 NORMAL SERVICE	563	XED16	0.025	L3230, L3460, L4000 (Light Load)	568	REM77N	0.012
UC175, UC200, UC301 NORMAL SERVICE	563	XED16	0.025	GASOLINE			
UC221, UC263 Shielded NORMAL SERVICE	563	XED16	0.025	F1500, F1850, H2000, H2150, H2470 High Comperssion	568	REM77N	0.012
JOHN DEERE				F1500, F1850, H2000, H2150, H2470 Low Comperssion	550	ED14	0.025
341, 400, 500 Series	550	ED14	0.025	F1500, F1850, H2000, H2150, H2470 Low Comperssion	572	XED14	0.025
341, 400, 500 Series	572	XED14	0.025	L3000, L3230, L3460, L4000 Low Comperssion	550	ED14	0.025
NATURAL & LP GAS				L3000, L3230, L3460, L4000 High Comperssion	568	REM77N	0.012
400, 500 Series	568	REM77N	0.012	L3000, L3230, L3460, L4000 Low Comperssion	572	XED14	0.025
LORAIN				Shielded Plug Low Comperssion	550	ED14	0.025
30, 37, 40, 50	563	XED16	0.025	Shielded Plug High Comperssion	550	ED14	0.025
A, L, O, R 7/8"-18 HEADS	578	REW82P	0.012	Shielded Plug High Comperssion	572	XED14	0.025
LUFKIN				Shielded Plug Low Comperssion	572	XED14	0.025
NORMAL SERVICE				RUSTON			
H795	578	REW82P	0.012	RK270GS Series	578	REW82P	0.012
SEVERE SERVICE				SOLAR TURBINE			
H1770, H2165	578	REW82P	0.012	Mars, Centaur	572	XED14	0.025
H1770, H2165	578	REW82P	0.012				
M.E.P. INDUSTRIES							
M.E.P. -6, -8, 10, -12 Unshielded	568	REM77N	0.015				



MAKE YEAR AND MODEL	SHIELDED 5/8"-24			MAKE YEAR AND MODEL	SHIELDED 5/8"-24		
	STOCK NO.	PLUG TYPE	GAP		STOCK NO.	PLUG TYPE	GAP
SOLAR TURBINE				WAUKESHA			
Mars, Centaur	550	ED14	0.025	Shielded type for D16 14mm Heads	563	XED16	0.025
Type H, Tauros	550	ED14	0.025	Shielded type for J8C 14mm Heads	557	XEJ8	0.025
Type H, Tauros	572	XED14	0.025	INLINE 8			
STOVER				8L-AT25GL/AT27GL (1/2' reach heads)	568	REM77N	0.012
DVA, DVA1	550	ED14	0.025	INTERMEDIATE SERIES			
DVA, DVA1	572	XED14	0.025	F1197G Inline 6	572	XED14	0.025
SUPERIOR				F1197G Inline 6	550	ED14	0.025
1965-58 GX825 Series	568	REM77N	0.015	F1905GR Inline 6	568	REM77N	0.015
1970-63 VG825 Series86	578	REW82P	0.012	VGF SERIES			
1970-63 VGT825 Series86	578	REW82P	0.012	140GK, 145GK, FC 18mm Heads	568	REM77N	0.015
1973-39 80G Series	550	ED14	0.025	180G, 180GB, 180GKB, 185GLB 18mm Heads	568	REM77N	0.015
1973-39 80G Series	572	XED14	0.025	1850G, H2475G, L3711G Natural Gas 18mm Heads	550	ED14	0.025
1973-39 80GX Series	572	XED14	0.025	1850G, H2475G, L3711G Natural Gas 18mm Heads	572	XED14	0.025
1973-39 80GX Series	550	ED14	0.025	190G, 190GLB, 195G, 195GK 18mm Heads	568	REM77N	0.015
1979-65 GT825 Series	568	REM77N	0.015	6BZ, 6LRZ, 6LRZB, 6MZA, 6MZR, ICK 18mm Heads	568	REM77N	0.015
1980-46 G510 Series	568	REM77N	0.015	6NK, 6WAK, 6WAKB, NKR, WAKR, LRORB 18mm Heads	568	REM77N	0.015
1980-51 G825 Series	568	REM77N	0.015	F1197GRSI, F1905GRSI Generator Set 18mm Heads	568	REM77N	0.015
1980-61 GT510 Series	568	REM77N	0.015	F2894G, F2894GRSI, F3520G, L5100GR 18mm Heads	568	REM77N	0.015
1980-76 SGT Series	568	REM77N	0.015	L5100GRSI, L5788GR 18mm Heads	568	REM77N	0.015
1980-79 GTL Series	568	REM77N	0.015	L5788GRSI, L7040G 18mm Heads	568	REM77N	0.015
2400 G Series	572	XED14	0.025	L7042GSIE, F3521GSIE 18mm Heads	568	REM77N	0.015
2400 G Series	550	ED14	0.025	VRN232, VRN155 18mm Heads	550	ED14	0.025
TELEDYNE (see Continental)				VRN232, VRN155 18mm Heads	572	XED14	0.025
UNIVERSAL				VHP Series			
18mm Heads	550	ED14	0.025	2895GL (1/2' reach heads) Inline 6	568	REM77N	0.012
18mm Heads	572	XED14	0.025	3521GL (1/2' reach heads) Inline 6	568	REM77N	0.012
WAUKESHA				5108GL (1/2" reach heads) V12 Series	568	REM77N	0.012
AT Series				5790GL (1/2' reach heads) V12 Series	568	REM77N	0.012
12V-AT25GL/AT27GL (1/2' reach heads)	568	REM77N	0.012	7042GL (1/2' reach heads) V12 Series	568	REM77N	0.012
GASOLINE				9390G, P9390GSI V16 Series	568	REM77N	0.012
140GK, 140GS, 145GK, 145GS 14mm Heads	563	XED16	0.025	9390GL (1/2" reach heads) V16 Series	568	REM77N	0.012
180G, 180GB, 180GL 14mm Heads	572	XED14	0.025	F2895G, F2895GSI Inline 6	568	REM77N	0.012
180G, 180GB, 180GL 14mm Heads	550	ED14	0.025	F3251G, F3521GSI Inline 6	568	REM77N	0.012
180GS, 185GS, 190GS, FC 14mm Heads	563	XED16	0.025	L5108G, L5108GSI, L5790G V12 Series	568	REM77N	0.012
185GL, 185GLB, 190G, 190GL, 190GLB 14mm Heads	550	ED14	0.025	L5790GSI, L7042G, L7042GSI V12 Series	568	REM77N	0.012
185GL, 185GLB, 190G, 190GL, 190GLB 14mm Heads	572	XED14	0.025	WHITE ENGINE, INC. (see Hercules)			
195G, 195GK, 195GKA, 195GL 14mm Heads	550	ED14	0.025	WHITE-SUPERIOR (see Superior)			
195G, 195GK, 195GKA, 195GL 14mm Heads	572	XED14	0.025	WORTHINGTON			
6BZ, LRORB, VLRORB, ICK 14mm Heads	550	ED14	0.025	CG, CCG, CCGX, DG, DDG	578	REW82P	0.012
6BZ, LRORB, VLRORB, ICK 14mm Heads	572	XED14	0.025	DHG, DRG, EEG	578	REW82P	0.012
6LRZ, 6LRZB, 6MZA, 6MZR, 6NK 14mm Heads	550	ED14	0.025	EHG, LFC, LCE	578	REW82P	0.012
6LRZ, 6LRZB, 6MZA, 6MZR, 6NK 14mm Heads	572	XED14	0.025	ML Turbocharged	578	REW82P	0.012
6NKR, 6NKR, 6SRKR, 6WAK, 6WAKB 14mm Heads	550	ED14	0.025	SDHG & SDHP Severe Service	578	REW82P	0.012
6NKR, 6NKR, 6SRKR, 6WAK, 6WAKB 14mm Heads	572	XED14	0.025	SLHC, SLHCA, SLHP	578	REW82P	0.012
CFR 14mm Heads	563	XED16	0.025	SUTC, SEGH, SWG	578	REW82P	0.012
D155G, D176G, VRG232 14mm Heads	563	XED16	0.025	UTC	578	REW82P	0.012
F1197GR, VRG155 14mm Heads	550	ED14	0.025				
F1197GR, VRG155 14mm Heads	572	XED14	0.025				
Shielded type for D14 14mm Heads	550	ED14	0.025				
Shielded type for D14 14mm Heads	572	XED14	0.025				



INDUSTRIAL SPARK PLUG GAPS

STK. NO.	PLUG TYPE	AVAIL. GAP	PACK QTY.	REACH INCHES	HEX INCHES	TERMINAL THREAD NUT	REPL. GASKET	STK. NO.	PLUG TYPE	AVAIL. GAP	PACK QTY.	REACH INCHES	HEX INCHES	TERMINAL THREAD NUT	REPL. GASKET
10mm THREAD DIAMETER								14mm THREAD DIAMETER							
877	Y82	.020	8	.312	14mm	NONE	NONE	644	RJ88P	.015	8	.375	13/16	BN-9A	N-678
1-1 / 8" - 12 THREAD DIAMETER								18mm THREAD DIAMETER							
598	RS79N	.012	8	.625	1	BN-9A	FGS-8A	1201	RTM78N	.012	4	.531	7/8	NONE	A-678
12.7mm THREAD DIAMETER								1202	RTM78N	.019	4	.531	7/8	NONE	A-678
14mm THREAD DIAMETER								1203	RTB78N	.012	4	.531	7/8	NONE	A-678
525	25	.030	8	1.00	.938	NONE	NONE	1205	RB77WPCC	.007	4	.813	7/8	NONE	A-678
1206	RC78WP	.012	6	.750	5/8	NONE	N-678	1219	KB75N	.012	4	.813	7/8	NONE	A-678
1208	RC78PYP	.017	6	.750	5/8	NONE	N-678	1225	RTM82WPCC	.012	4	.500	7/8	NONE	NONE
1209	RC78YCC15	.015	6	.750	5/8	NONE	N-678	1230	FB77WPCC	.012	4	.813	7/8	None	A-678
1213	RC78PYP	.012	4	.750	5/8	NONE	N-678	204	D14N	.025	8	.531	7/8	BN-9A	A-678
1218	RC78WYP11	.011	6	.750	5/8	NONE	N-678	213	RHM77N	.020	8	.531	7/8	SHIELDED	A-678
1220	RTV85G	.025	4	.460	5/8	BN-9A	N-678	214	RTM77N	.012	8	.531	1	BN-9A	A-678
					Taper Seat			217	RM77PP	.015	8	.531	7/8	BN-9A	A-678
1221	RC78WYP15	.015	6	.750	5/8	NONE	N-678	222	RHM78PP	.012	4	.531	7/8	SHIELDED	A-678
1224	RL85G	.015	4	.500	13/16	BN-9A	N-678	223	RTM77PP	.012	4	.531	7/8	BN-9A	A-678
1232	RTN79WYP	.015	4	.750	15/16	NONE	N-678	225	RB75PP	.012	4	.813	7/8	BN-9A	A-678
218	RC78PYP	.015	6	.750	5/8	NONE	N-678	226	RB76PP	.012	4	.813	7/8	BN-9A	A-678
219	RC78PYP	.021	6	.750	5/8	NONE	N-678	229	KB77WPCC	.012	4	.813	7/8	NONE	A-678
224	RN79G1	.010	8	.750	13/16	NONE	N-678	233	RM82WPCC	.012	4	.531	7/8	BN-9A	A-678
230	RX85PYP	.012	6	.500	5/8	NONE	N-678	234	RHM78N	.015	4	.531	7/8	SHIELDED	A-678
232	RC78PYP17	.017	6	.750	5/8	NONE	N-678	235	RTB77WPCC	.012	4	.813	1	BN-9A	A-678
241	RC78PYP25	.025	6	.750	5/8	NONE	N-678	236	RHM78WPCC	.012	4	.531	7/8	SHIELDED	A-678
243	RC78PYP15	.015	6	.750	5/8	NONE	N-678	237	RB77CC	.012	4	.813	7/8	NONE	A-678
244	RC78PYP21	.021	6	.750	5/8	NONE	N-678	242	RB75WPCC	.012	4	.813	13/16	NONE	A-678
247	RN79PYP17	.017	4	.750	13/16	NONE	N-678	245	RB77WPCC	.007	4	.813	7/8	NONE	A-678
248	RN79PYP25	.025	4	.750	13/16	NONE	N-678	249	RB77WPCC	.007	4	.813	7/8	NONE	A-678
502	D21	.027	6	.500	7/8	NONE	N-678	503	REM84P	.015	8	.500	7/8	SHIELDED	A-678
517	XMJ17	.025	8	.375	13/16	SHIELDED	N-678	504	N21	.025	4	.750	13/16	NONE	A-678
522	REL89G	.015	1	.500	13/16	SHIELDED	N-678	505	ED89D	.025	8	.500	7/8	SHIELDED	A-678
530	RN79G	.015	8	.750	13/16	NONE	N-678	506	D6	.027	6	.500	7/8	NONE	A-678
535	RL15B	.015	8	.500	13/16	BN-9A	N-678	509	D9	.025	6	.500	7 / 8	BN-9A	N-678
540	RTN79G	.015	8	.750	15/16	BN-9A	N-678	514	D14	.025	6	.500	7 / 8	BN-9A	N-678
551	RHL79G	.015	1	.500	7/8	SHIELDED	N-678	515	D15Y	.027	6	.500	7/8	NONE	A-678
556	RTL85G	.015	8	.500	13/16	BN-9A	N-678	516	D16	.025	6	.500	7/8	ZN-9A	A-678
557	XEJ8	.025	8	.375	13/16	SHIELDED	N-678	519	RM77N	.015	8	.531	7/8	BN-9A	A-678
567	XEJ12	.025	8	.375	13/16	SHIELDED	N-678	521	XMD21	.025	8	.531	7/8	SHIELDED	A-678
573	XMJ20	.025	8	.375	13/16	SHIELDED	N-678	523	D23	.030	8	.500	7/8	NONE	A-678
575	RHN79G	.015	1	.750	7/8	SHIELDED	N-678	526	RD15Y	.027	6	.500	7/8	NONE	A-678
588	XMJ14	.025	8	.375	13/16	SHIELDED	N-678	529	D14N	.015	8	.531	7 / 8	BN-9A	A-678
594	TJ83	.025	8	.375	13/16	BN-9A	N-678	541	RD16	.027	6	.500	7/8	NONE	A-678
599	J99	NA	8	.375	13/16	NONE	N-678	542	B86N	.012	8	.813	7/8	BN-9A	A-678
603	XML12	.025	8	.500	13/16	SHIELDED	N-678	543	D89D	.025	8	.500	7/8	NA-9E	A-678
610	REL88B	.020	8	.500	13/16	SHIELDED	N-678	547	RTM77N	.019	8	.531	1	BN-9A	A-678
612	RML12	.025	8	.500	13/16	SHIELDED	N-678	548	RTM79	.025	8	.531	7/8	BN-9A	A-678
614	XEN14	.025	8	.750	7/8	SHIELDED	N-678	549	D18Y	.027	6	.500	7/8	NONE	A-678
616	XMN12	.025	8	.750	7/8	SHIELDED	N-678	550	ED14	.025	8	.531	7/8	SHIELDED	A-678
633	XML15Y	.025	8	.500	13/16	SHIELDED	N-678	555	UD16	.025	6	.500	7/8	ZN-9A	A-678
642	RN79G	.025	8	.750	13/16	NONE	N-678	563	XED16	.025	8	.531	7/8	SHIELDED	A-678
								564	D16J	.030	6	.500	7/8	NONE	A-678
								566	M82N	.015	8	.531	7/8	BN-9A	A-678
								568	REM77N	.015	8	.531	7/8	SHIELDED	A-678



STK. NO.	PLUG TYPE	AVAIL. GAP	PACK QTY.	REACH INCHES	HEX INCHES	TERMINAL THREAD NUT	REPL. GASKET	STK. NO.	PLUG TYPE	AVAIL. GAP	PACK QTY.	REACH INCHES	HEX INCHES	TERMINAL THREAD NUT	REPL. GASKET
18mm THREAD DIAMETER								7 / 8" - 18 THREAD DIAMETER							
571	RM79F	.015	8	.500	7/8	BN-9A	A-678	580	W80N	.013	8	.600	15/16	BN-9A	A-478
572	XED14	.025	8	.531	7/8	SHIELDED	A-678	582	RW82P	.012	8	.625	15/16	BN-9A	A-478
576	RB76N	.012	8	.802	7/8	BN-9A	A-678	589	W89D	.025	8	.625	15/16	NA-9E	A-478
583	RHM83N	.015	8	.531	7/8	SHIELDED	A-678	595	C95F	.020	8	.625	11/8	NA-9E	A-478
585	RHM85G	.015	1	.500	7/8	SHIELDED	A-678	623	RGC80F	.013	1	.625	11/8	NONE	A-478
586	RGM86N	.013	1	.500	7/8	NONE	A-678	631	RW78N	.012	4	.860	15/16	BN-9A	A-478
591	RM85G	.013	8	.500	7/8	BN-9A	A-678	635	RHW78N	.012	4	.860	1	SHIELDED	A-478
593	RD18Y	.035	6	.500	7/8	NONE	A-678	638	RTW80N	.012	1	.625	1	BN-9A	A-478
596	RHM77N	.015	8	.531	7/8	SHIELDED	A-678	645	RTW83F	.012	1	.625	1	BN-9A	A-478
597	K97F	.020	8	.688	1	ZN-9A	A-678								
624	RHB81N	.012	8	.813	7/8	SHIELDED	A-678								
625	D78Y	.015	8	.500	7/8	ZN-9A	A-678								
630	M82N	.012	8	.531	7/8	BN-9A	A-678								
634	RB77WPCC	.012	4	.813	7/8	NONE	A-678								
636	RB77WPC	.012	4	.813	7/8	NONE	A-678								
639	RHM83N	.025	8	.531	7/8	SHIELDED	A-678								
640	RM77N	.012	8	.531	7/8	BN-9A	A-678								
641	RM77N	.020	8	.531	7/8	BN-9A	A-678								
643	RB75N	.012	4	.802	7/8	NONE	A-678								
646	RTB80N	.012	8	.813	7/8	BN-9A	A-678								
647	M76R	.016	8	.500	7/8	ZN-9A	M-674								
649	XMD15	.025	8	.531	7/8	SHIELDED	A-678								
91	H14Y	.035	4	.438	13/16	NONE	A-678								
7 / 8" - 18 THREAD DIAMETER															
1204	RHW80PP	.012	8	.625	1	SHIELDED	A-478								
1207	RW80PP	.012	8	.625	15/16	BN-9A	A-478								
200	RW80N	.015	4	.625	1	BN-9A	A-478								
201	W77N	.012	8	1.000	15/16	BN-9A	A-478								
202	W80N	.020	8	.600	15/16	BN-9A	A-478								
203	W85N	.020	8	.600	15/16	BN-9A	A-478								
206	RW77N	.015	4	1.000	1	BN-9A	A-478								
228	RW77PP	.012	4	1.000	15/16	BN-9A	A-478								
510	W10	.025	8	.625	15/16	BN-9A	A-478								
513	C97B	.025	8	1.250	11/8	A-146	A-478								
518	W18	.025	8	.750	15/16	NA-9E	A-478								
520	W20	.025	8	.625	15/16	BN-9A	A-478								
532	RHW80N	.013	4	.625	1	SHIELDED	A-478								
534	REW80N	.012	8	.600	15/16	SHIELDED	A-478								
539	W77N	.015	8	1.000	15/16	BN-9A	A-478								
544	HW83F	.012	1	.625	1	SHIELDED	A-478								
545	W85N	.013	8	.600	15/16	BN-9A	A-478								
552	RGC77N	.012	1	1.000	1	NONE	A-478								
553	RW80N	.012	4	.625	1	BN-9A	A-478								
559	RW83F	.012	8	.625	1	BN-9A	A-478								
561	W16Y	.025	8	.625	15/16	BN-9A	A-478								
562	W95D	.040	8	.625	15/16	A-146	A-478								
565	RW77N	.012	4	1.000	1	BN-9A	A-478								
569	W14	.030	8	.625	15/16	BN-9A	A-478								
577	RHW77N	.015	4	1.000	1	SHIELDED	A-478								
578	REW82P	.012	8	.625	1	SHIELDED	A-478								
579	RHW79N	.012	4	.625	1	SHIELDED	A-478								



Heat Range	Thread Reach (inches)	Hex Size (inches)	STANDARD			INTERGRAL COIL			SHIELDED		
			Copper Plus	Precious Metal	Precious Metal Long Life	13/16" External Thread	13/16" External Thread Precious Metal	1" Internal Threads	5/8" - 24	3/4" - 20	3/4" - 20 Precious Metal
14mm THREAD DIAMETER											
4	3/8"	13/16"				TJ83					
3	1/2"	5/8"		RX85PYP							
6	1/2"	13/16"							REL89G*		
4	1/2"	13/16"	RL15B	RL85G					REL88B*		
4	1/2"	13/16"					RTL85G				
3	1/2"	7/8"								RHL79G*	
3	3/4"	5/8"		RC78PYP							
2	3/4"	5/8"	RC78YCC15	RC78PYP15 RC78PYP17 RC78PYP21 RC78PYP25	RC78WP RC78WYP11 RC78WYP15						
2	3/4"	13/16"		RN79G RN79G1	RN79PYP17 RN79PYP25					RHN79G*	
2	3/4"	15/16"					RTN79G RTN79WYP15				
18mm THREAD DIAMETER											
7	1/2"	7/8"	D89D						ED89D*		
6	1/2"	7/8"	D14N								
5	1/2"	7/8"		RM85G							RHM85G*
5	1/2"	7/8"	D78Y								
4	1/2"	7/8"	M82N		RM82WPCC		RTM82WPCC		REM84P*	RHM83N*	
3	1/2"	7/8"	RM79F			RTM79					
3	1/2"	7/8"	RM77N	RM77PP		RTM77N RTM78N	RTM77PP	RGM86N	REM77N*	RHM77N* RHM78N*	RHM78WPCC* RHM78PP*
7	0.691"	1"	K97F								
1	13/16"	13/16"			RB75WPCC						
5	13/16"	7/8"	B86N								
1	13/16"	7/8"				RTB78N RTB80N				RHB81N*	
1	13/16"	7/8"	RB77CC RB77N KB75N RB75N	RB75PP	FB77WPCC KB77WPCC RB77WPCC RB77WPC		RTB77WPCC				
1	13/16"	7/8"	RB76N	RB76PP							
7/8" - 18mm THREAD DIAMETER											
7	5/8"	15/16"	W95D W89D								
7	5/8"	15/16"	W20								
6	5/8"	15/16"	W16Y W14 W10								
5	5/8"	15/16"	W85N	RW82P							
3	5/8"	15/16"	W80N RW80N	RW80PP							
4	5/8"	1"							REW82P*		
3	5/8"	1"	RW83F			RTW83F RTW80N			REW80N*	RHW80N* RHW79N* HW83F*	RHW80PP*
7	5/8"	1 1/8"	C95F								
3	5/8"	1 1/8"						RGC80F			
7	3/4"	15/16"	W18								
3	.860"	1"	RW78N							RHW78N*	
3	1"	1"	W77N RW77N		RW77PP					RHW77N*	
3	1"	1 1/8"						RGC77N			
7	1 1/4"	1 1/8"	C97B								
1 1/8" - 12mm THREAD DIAMETER											
3	0.595	1	RS79N								

HEAT RANGE (IMEP)		IMEP established per SAE J549						
COLD	1	2	3	4	5	6	7	HOT
		400+	350-400	300-350	250-300	200-250	150-200	

* 1" shielded spark plug depth.
• 2" shielded spark plug depth

REPLACEMENTS FOR DISCONTINUED SPARK PLUGS



This list contains industrial spark plugs that have been discontinued. See the Champion Master Application Catalog. Refer to the Champion policy on Unsalable Product or consult your supplier or Champion Representative on the handling of these plug types.

Discont'd Plug	Replaced By Plug	Discont'd Plug	Replaced By Plug	Discont'd Plug	Replaced By Plug	Discont'd Plug	Replaced By Plug	Discont'd Plug	Replaced By Plug
0-COM	510 / W10	J13-0	525 / 25	RJ18Y	58 / RJ18YC	JAS43	561 / W16Y	E7	563 / XED16
C0	569 / W14	J13Y	63 / RJ14YC	2	518 / W18	JB43	518 / W18	J7	871 / RJ8C
1	569 / W14	K13	514 / D14	2-COM	518 / W18	JC43	561 / W16Y	J7J	871 / RJ8C
1-COM	569 / W14	N13L	101 / RN13LYC	2-COM-L	518 / W18	G44	520 / W20	K7	506 / D6
C1	518 / W18	N13Y	405 / RN14YC	N2	818 / RN2C	GH44	518 / W18	K7	506 / D6
ORD-1	588 / XMJ14	RN13L	101 / RN13LYC	RN2	818 / RN2C	45	562 / W95D	N7Y	332 / RN7YC
TAC-1	610 / REL88B	14	541 / RD16	RN2G	818 / RN2C	46	562 / W95D	R7B	506 / D6
10	541 / RD16	A14	525 / 25	TAC-2	612 / RML12	49	543 / D89D	RN7Y	332 / RN7YC
10-COM	523 / D23	A14-0	525 / 25	UJ2J	825 / J4C	E49	505 / ED89D	XE7	563 / XED16
10-COM-64	523 / D23	C14	525 / 25	20	520 / W20	XE49	505 / ED89D	XEJ7	557 / XEJ8
C10S	557 / XEJ8	EJ14	567 / XEJ12	RJ20Y	58 / RJ18YC	5	429 / 3X	XEL7A	610 / REL88B
D10	509 / D9	F14Y	21 / RF14YC	21	510 / W10	5-COM	509 / D9	XJ7	871 / RJ8C
EH10	610 / REL88B	FN14LY	412 / RC12LYC	XED21	563 / XED16	5M	509 / D9	72	510 / W10
H10	854 / RH10C	H014S	NR	22	520 / W20	5MJ	509 / D9	73	510 / W10
J10-COM	102 / RJ6C	J14	592 / RJ12C	J23	525 / 25	C5	569 / W14	RB75WPC	242 / RB75WPCC
J10-COM-J	102 / RJ6C	J14-64CL	599 / J99	A24	525 / 25	J5J	102 / RJ6C	D77V	506 / D6
J10Y	14 / RJ12YC	J14C1	599 / J99	G24	525 / 25	L5	874 / RL82C	HW77N	596 / RHM77N
RF10	129 / RF10C	J14J	846 / CJ14	A25	525 / 25	L5J	874 / RL82C	RM78P	519 / RM77N
RH10	854 / RH10C	J14Y	63 / RJ14YC	A26	541 / RD16	N5	123 / RN5C	REN79G	NR
RN10Y	322 / RN11YC4	J14YC	63 / RJ14YC	29	525 / 25	RN5	123 / RN5C	8	541 / RD16
UK10	509 / D9	MJ14	588 / XMJ14	3	561 / W16Y	X5-COM	509 / D9	8-COM	541 / RD16
XEH10	610 / REL88B	N14LY	101 / RN13LYC	3-COM	518 / W18	A53	518 / W18	8-COM-C	523 / D23
RWP102	582 / RW82P	N14Y	405 / RN14YC	N3	880 / RN3C	AA53	518 / W18	8-COM-D	523 / D23
ON11Y	322 / RN11YC4	RD14M	514 / D14	RN3	880 / RN3C	B53	561 / W16Y	8-COM-K	526 / RD15Y
11	541 / RD16	RD14M	514 / D14	30	525 / 25	JA53	518 / W18	8-SPEC	541 / RD16
EH11	610 / REL88B	RF14Y	21 / RF14YC	31	525 / 25	JC53	518 / W18	D8	597 / K97F
EJ11	567 / XEJ12	RF14Y4	21 / RF14YC	32	525 / 25	00-55-1	627 / F-6A-13	DJ8	865 / RDJ8J
F11Y	22 / RF11YC	RJ14Y	63 / RJ14YC	34	525 / 25	00-55-2	NR	DL8	597 / K97F
F11YC	22 / RF11YC	RN14Y	405 / RN14YC	A34	525 / 25	00-55-3	NR	DL8C	597 / K97F
H11	854 / RH10C	UEJ14	567 / XEJ12	35	520 / W20	6	518 / W18	E8-COM	563 / XED16
H11J	854 / RH10C	XD14	514 / D14	35-COM	518 / W18	6-COM	514 / D14	ED8	597 / K97F
J11	511 / J11C	XEJ14	567 / XEJ12	CH36001	547 / RTM77N	6-COM-62	514 / D14	EDL8	597 / K97F
J11J	511 / J11C	15	541 / RD16	CH36002	548 / RTM79	6-COM-D	514 / D14	EH08	610 / REL88B
J11Y	14 / RJ12YC	15A	541 / RD16	CH36003	540 / RTN79G	6M	514 / D14	EH8	610 / REL88B
K11	509 / D9	15-SPEC	541 / RD16	CH36004	556 / RTL85G	6MJ	506 / D6	EJ8	557 / XEJ8
N11Y	322 / RN11YC4	A15	525 / 25	CH36006	NR	DJ6	851 / DJ6J	EJ8J	557 / XEJ8
RBL11Y6	79 / RV15YC6	C15	502 / D21	CH36007	NR	DJ6Y	872 / RDJ7Y	H08A	533 / UJ11G
RF11Y	22 / RF11YC	J15	514 / D14	CH36008	556 / RTL85G	EJ6	557 / XEJ8	J8	871 / RJ8C
RJ11Y	14 / RJ12YC	K15J	514 / D14	CH36009	540 / RTN79G	EJ6J	557 / XEJ8	J8J	871 / RJ8C
RN11Y	322 / RN11YC4	UD15Y	526 / RD15Y	CH36010	625 / D78Y	J6	102 / RJ6C	JT8	840 / RCJ8
RN11YC	322 / RN11YC4	XEC15	563 / XED16	REB37E	NR	J6J	102 / RJ6C	K8	509 / D9
XEH11	610 / REL88B	16	541 / RD16	CH38016	NR	J6JM	102 / RJ6C	N8	123 / RN5C
XEJ11	567 / XEJ12	C16C	561 / W16Y	4	561 / W16Y	N6	123 / RN5C	RJ8	871 / RJ8C
XH11	854 / RH10C	ED16	563 / XED16	4-COM	506 / D6	N6Y	339 / RN6YC	RJ8J	871 / RJ8C
UK112	506 / D6	H16	506 / D6	C4X	561 / W16Y	RD6	506 / D6	RN8	123 / RN5C
EJ12	567 / XEJ12	H16A	506 / D6	J4	825 / J4C	RJ6	102 / RJ6C	TJ8J	840 / RCJ8
J12	592 / RJ12C	N16Y	405 / RN14YC	J4J	825 / J4C	RJ6J	102 / RJ6C	UCJ8G	840 / RCJ8
J12Y	14 / RJ12YC	N16YC	405 / RN14YC	N4	104 / RN4C	RN6	123 / RN5C	UJ8	871 / RJ8C
K12G	514 / D14	RD16J	541 / RD16	QC4	561 / W16Y	RN6Y	339 / RN6YC	X8-COM	541 / RD16
KJ12	592 / RJ12C	RD16M	541 / RD16	RJ4	825 / J4C	UJ6	102 / RJ6C	XE8-COM	563 / XED16
N12Y	404 / RN12YC	RN16Y	405 / RN14YC	RJ4J	825 / J4C	UJ6M	102 / RJ6C	XEH8	557 / XEJ8
RF12	129 / RF10C	UED16	563 / XED16	RN4	104 / RN4C	X6-COM	514 / D14	XEH8J	557 / XEJ8
RF12-5	129 / RF10C	UK16V	506 / D6	TAC-4	603 / XML12	XD6E6-COM	572 / XED14	XEJ8J	557 / XEJ8
RJ12Y	14 / RJ12YC	XD16	541 / RD16	X4-COM	506 / D6	XE6-COM	572 / XED14	XJ8	871 / RJ8C
RJ12Y6	66 / RJ18YC6	XD16J	541 / RD16	40	597 / K97F	XEJ6	557 / XEJ8	XJ8J	871 / RJ8C
RJ12YC6	66 / RJ18YC6	H17	509 / D9	41	597 / K97F	XEJ6J	557 / XEJ8	HW80N	532 / RHW80N
RN12Y	404 / RN12YC	H17A	509 / D9	42	597 / K97F	62S	572 / XED14	RF80N	129 / RF10C
XH12	854 / RH10C	18	514 / D14	43	518 / W18	A64	541 / RD16	RGC80N	NR
13	541 / RD16	H18Y	857 / RH18Y	A43	569 / W14	7	541 / RD16	RGC80N	NR
A13	525 / 25	J18Y	58 / RJ18YC	B43	561 / W16Y	7-COM	541 / RD16	RM80F	571 / RM79F
J13	525 / 25	J18YC	58 / RJ18YC	JA43	561 / W16Y	C7	541 / RD16	808	529 / D14N

NR - No Replacement



REPLACEMENTS FOR DISCONTINUED SPARK PLUGS

This list contains industrial spark plugs that have been discontinued. See the Champion Master Application Catalog. Refer to the Champion policy on Unsalable Product or consult your supplier or Champion Representative on the handling of these plug types.

Discont'd Plug	Replaced By Plug	Discont'd Plug	Replaced By Plug	Discont'd Plug	Replaced By Plug	Discont'd Plug	Replaced By Plug
EC85N	534 / REW80N						
RL85P	1224 / RL85G						
TN85Y	540 / RTN79G						
RL86	830 / RL86C						
C87S	610 / REL88B						
L87Y	327 / RL87YC						
RJ87P	14 / RJ12YC						
RL87Y	327 / RL87YC						
C88	610 / REL88B						
C88S	610 / REL88B						
ED88F	505 / ED89D						
H88	538 / RH8C						
K88S	610 / REL88B						
L88	830 / RL86C						
RC88S	610 / REL88B						
UED88G	572 / XED14						
RHL89G	NR						
UED89D	505 / ED89D						
XED89D	505 / ED89D						
XED89DXI	505 / ED89D						
9	502 / D21						
9-COM	523 / D23						
D9J	509 / D9						
D9JM	509 / D9						
ED9	550 / ED14						
EH9	610 / REL88B						
F9Y	409 / RF9YC						
F9YC	409 / RF9YC						
H9	538 / RH8C						
H9-COM	538 / RH8C						
H9J	538 / RH8C						
K9	509 / D9						
N9Y	415 / RN9YC						
RD9	509 / D9						
RF9Y	409 / RF9YC						
RF9Y5	409 / RF9YC						
RN9Y	415 / RN9YC						
XD9	509 / D9						
XE9	572 / XED14						
XED9-COM	572 / XED14						
XEH9	610 / REL88B						
XH9	538 / RH8C						
EW90	NR						
E901	534 / REW80N						
ED91	505 / ED89D						
HC95F	544 / HW83F						
K98F	597 / K97F						



CAUTION. DO NOT USE THIS CHART

UNLESS YOU ARE UNABLE TO FIND YOUR VEHICLE OR EQUIPMENT LISTED IN THE APPLICATION SECTIONS OF THIS CATALOG.

A/C Delco To Champion

A/C Delco	Champion	A/C Delco	Champion	A/C Delco	Champion	A/C Delco	Champion	A/C Delco	Champion
373	D9 / 509	WR43LR	RML12 / 612	C77L	W18 / 518	C77	W16Y / 561	C75	W14 / 569
C73	W10 / 510	800LY	B86N / 542	78S	W20 / 520	701Y	W85N / 545	700YX	W80N / 580
700Y	W80N / 580	43LS	H14Y / 91	18A	D89D / 543	C83	D9 / 509	404	RL85G / 1224
C85S	RD15Y / 526	373	D6 / 506	26	25 / 525	18	W89D / 589	17	W95D / 562
16	K97F / 597	14	K97F / 597	WR87	XMD21 / 521	WR86	XMD21 / 521	WR84	XMD15 / 649
WR47	XMJ14 / 588	WR46	XMJ17 / 517	WR44LS	XML15Y / 633	WR44	XMJ14 / 588	16L	K97F / 597
S82F	D9 / 509	WR43L	XML12 / 603	WR43	XMJ14 / 588	SR86E	XED16 / 563	SR84E	XED14 / 572
SR47XL	XEN14 / 614	SR47LE	REL88B / 610	SR47E	XEJ12 / 567	SR46E	XEJ12 / 567	SR45LE	REL88B / 610
SR44E	XEJ8 / 557	SR43LE	REL88B / 610	SR43E	XEJ8 / 557	C81	D14N / 529	S83F	D9 / 509
C82	D9 / 509	R800	RM77N / 519	G59	25 / 525	G56	25 / 525	G54	C95F / 595
G53	C95F / 595	CR83	D9 / 509	CR82	D9 / 509	C88L	D23 / 523	C88	D21 / 502
C87	D16 / 516	C86S	D18Y / 549	C86	D14N / 529	C86	D14 / 514	S85F	D14 / 514
C85	D14 / 514								

Allis-Chalmers To Champion

Allis-Chalmers	Champion	Allis-Chalmers	Champion	Allis-Chalmers	Champion	Allis-Chalmers	Champion	Allis-Chalmers	Champion
74905796	N5C / 120	79001652	J6C / 823	79001651	N5C / 120	74905800	D16 / 516	74905798	N5C / 120
4907335	J8C / 841	4905800	D16 / 516	4905797	N5C / 120				

Autolite To Champion

Autolite	Champion	Autolite	Champion	Autolite	Champion	Autolite	Champion	Autolite	Champion
2222	XED14 / 572	373	D9 / 509	2247	XMJ20 / 573	2246	XEJ12 / 567	2245	XMJ17 / 517
2244	XEJ8 / 557	2243	XMJ14 / 588	2242	XEJ8 / 557	2227	XMD21 / 521	2226	XMD21 / 521
2225	XED16 / 563	2285	REL88B / 610	2223	XMD15 / 649	2304	XMN12 / 616	436	H14Y / 91
398	N21 / 504	388	D21 / 502	386	RD16 / 541	379	D89D / 543	378	D23 / 523
377	D21 / 502	376	D16 / 516	375	D14 / 514	374	D9 / 509	2224	XMD21 / 521
2696	D9 / 509	3116	D18Y / 549	3095	25 / 525	3077	W89D / 589	3076	W14 / 569
3075	W14 / 569	3074	W10 / 510	3035	UD16 / 555	2832	D6 / 506	2775	D16 / 516
2773	D9 / 509	2248	XEJ12 / 567	2697	D14 / 514	372	D6 / 506	2695	D6 / 506
2693	D6 / 506	2384	XML12 / 603	2384	XML15Y / 633	2344	RML12 / 612	2327	REL88B / 610
2326	REL88B / 610	2325	REL88B / 610	2307	XEN14 / 614	2305	XMN12 / 616	2772	D9 / 509

BERU To Champion

BERU	Champion	BERU	Champion	BERU	Champion	BERU	Champion	BERU	Champion
18GZ7	RB76N / 576	143CPU	RN79G / 530	14R4ADP	RL85G / 1224	14R4CDP	RN79G / 530	14R4DP	RL85G / 1224
18GZ577	RB75WPCC / 242	18GZ677	RB77WPC / 636						

BG To Champion

BG	Champion	BG	Champion	BG	Champion	BG	Champion	BG	Champion
RB485S	RHM85G / 585	RB485SA	RHM85G / 585	RB590	RL85G / 1224	RB590S	REL89G / 522	RB792S	RHL79G / 551
RB842S	RHW80N / 531	RB485S	REM84P / 503	RB959SA	RHM77N / 596	RB212	RW82P / 582	RB959S	RHM77N / 596
RB485	RM85G / 591	RB442SAW	RHM83N / 583	RB993R	RN79G / 530	RB312S	REW82P / 578	RB442SW	RHM83N / 583
RB126SD	RHW77N / 577	RB1141	RW77N / 565	RB106	RS79N / 598	BG883T	RF10C / 129	RB312S	ED89D / 505
RB412	RW82P / 582								

Bosch To Champion

Bosch	Champion	Bosch	Champion	Bosch	Champion	Bosch	Champion	Bosch	Champion
M4A2	D6 / 506	M8AC0	D9 / 509	M8A0	D9 / 509	M8A	D9 / 509	M7AC	D6 / 506
M7A	D6 / 506	M5AS	D6 / 506	M5AC	D6 / 506	W10C	N21 / 504	M4AC	D6 / 506
M10A0	D14 / 514	M4A1	D6 / 506	M12A	D16 / 516	M10AC0	D14 / 514	M10A	D14 / 514
60999S	RB77WPCC / 634	7311	RN79G / 642	M5A	D6 / 506	7306	KB77WPCC / 229	WR3CPP33	RN79G / 642
MR3DPP330	FB77WPCC / 1230	MR3DPP330	KB77WPCC / 229	MR3BPP330	RM77PP / 217	MR3DPP33	RB75PP / 225	FR3KI1332	RC78WYP15 / 1221
7307	RB75WPCC / 242	WR7CE+	RN5C / 123	7306	RB77WPCC / 634	7303	RM77PP / 217	7302	RB75PP / 225
60999Z	RB77CC / 237								

Case To Champion

Case	Champion	Case	Champion	Case	Champion	Case	Champion	Case	Champion
AO5999AB	J8C / 841	O5999B	J8C / 841	TG44840	D16 / 516	TM20007	H10C / 844	TM20699	L86C / 306

Caterpillar To Champion

Caterpillar	Champion	Caterpillar	Champion	Caterpillar	Champion	Caterpillar	Champion	Caterpillar	Champion
9B0444	J6C / 823	3B6583	H10C / 844	2A3643	D16 / 516	2B9548	W14 / 569	2W9486	N9YC / 300
1948518	KB77WPCC / 229	8F6347	CJ8 / 843	2848313	KB77WPCC / 229	9M4141	J12YC / 10	23643	D16 / 516
9M4142	J12YC / 10								



CAUTION. DO NOT USE THIS CHART
UNLESS YOU ARE UNABLE TO FIND YOUR VEHICLE OR EQUIPMENT LISTED IN THE APPLICATION SECTIONS OF THIS CATALOG.

Champion Plug Type To Champion

Champion Plug	Champion	Champion Plug	Champion	Champion Plug	Champion	Champion Plug	Champion	Champion Plug	Champion
Type		Type		Type		Type		Type	
RB77WPCC (Gap .007)	1205	RTM77PP (Gap .012)	223	RTM77N (Gap .019)	547	RTM77N (Gap .012)	214	W20 (Gap .025)	520
RM77N (Gap .020)	641	D14N (Gap .015)	529	RM77N (Gap .015)	519	RHM77N (Gap .020)	213	RB77WPCC (Gap .012)	634
REM77N (Gap .015)	568	M76R (Gap .016)	647	RHM83N (Gap .015)	583	D78Y (Gap .015)	625	RB77WPC (Gap .012)	636
RB77CC (Gap .012)	237	RTB77WPCC (Gap .012)	235	KB77WPCC (Gap .012)	229	RB76PP (Gap .012)	226	RB76N (Gap .012)	576
RHM77N (Gap .015)	596	RHB81N (Gap .012)	624	RM77N (Gap .012)	640	RB75WPCC (Gap .012)	242	B86N (Gap .012)	542
RM85G (Gap .013)	591	RHM85G (Gap .015)	585	REM84P (Gap .015)	503	RHM83N (Gap .025)	639	RM82WPCC (Gap .012)	233
M82N (Gap .015)	566	RTM82WPCC (Gap .012)	1225	RHM78N (Gap .015)	234	RTN79WYP (Gap .015)	1232	RTB80N (Gap .012)	646
RTM79 (Gap .025)	548	RM79F (Gap .015)	571	RTM78N (Gap .019)	1202	RTM78N (Gap .012)	1201	RTB78N (Gap .012)	1203
RHM78WPCC (Gap .012)	236	RHM78PP (Gap .012)	222	M82N (Gap .012)	630	RW78N (Gap .012)	631	W80N (Gap .013)	580
XMJ20 (Gap .025)	573	XMJ14 (Gap .025)	588	XEJ12 (Gap .025)	567	XEJ8 (Gap .025)	557	RHW77N (Gap .015)	577
RM77PP (Gap .015)	217	RW77N (Gap .015)	206	RB75PP (Gap .012)	225	RW77PP (Gap .012)	228	W77N (Gap .012)	201
RJ88P (Gap .015)	644	RHW78N (Gap .012)	635	RML12 (Gap .025)	612	D89D (Gap .025)	543	ED89D (Gap .025)	505
K97F (Gap .020)	597	RHW79N (Gap .012)	579	REW80N (Gap .012)	534	RGC80F (Gap .013)	632	RHW80N (Gap .013)	532
RHW80PP (Gap .012)	1204	RTW80N (Gap .012)	638	RW80N (Gap .012)	553	RW80N (Gap .015)	200	RW80PP (Gap .012)	1207
W77N (Gap .015)	539	RC78PYP17 (Gap .017)	232	D14 (Gap .025)	514	D9 (Gap .025)	509	RTN79G (Gap .015)	540
RN79PYP17 (Gap .017)	247	RN79G (Gap .025)	642	RN79G (Gap .015)	530	XEN14 (Gap .025)	614	XMN12 (Gap .025)	616
RHN79G (Gap .015)	575	RC78WP (Gap .012)	1206	RC78YCC15 (Gap .015)	1209	TJ83 (Gap .025)	594	RC78PYP21 (Gap .021)	244
RW77N (Gap .012)	565	RC78PYP15 (Gap .015)	243	RC78PYP (Gap .021)	219	RC78PYP (Gap .017)	1208	RC78PYP (Gap .015)	218
RX85PYP (Gap .012)	230	REL89G (Gap .015)	522	REL88B (Gap .020)	610	RTL85G (Gap .015)	556	RHL79G (Gap .015)	551
XML15Y (Gap .025)	633	RL15B (Gap .015)	535	XML12 (Gap .025)	603	RC78PYP25 (Gap .025)	241	N21 (Gap .025)	504
W18 (Gap .025)	518	W16Y (Gap .025)	561	W14 (Gap .030)	569	W10 (Gap .025)	510	RGC77N (Gap .012)	552
D16J (Gap .030)	564	D18Y (Gap .027)	549	RD16 (Gap .027)	541	RD15Y (Gap .027)	526	25 (Gap .030)	525
D23 (Gap .030)	523	D14N (Gap .025)	204	D6 (Gap .027)	506	Y82 (Gap .020)	877	D21 (Gap .027)	502
H14Y (Gap .035)	91	W80N (Gap .020)	202	J99	599	RTV85G (Gap .025)	1220	RD18Y (Gap .035)	593
XMD21 (Gap .025)	521	XMJ17 (Gap .025)	517	RN79PYP25 (Gap .025)	248	RN79G1 (Gap .010)	224	RL85G (Gap .015)	1224
D15Y (Gap .027)	515	RS79N (Gap .012)	598	REW82P (Gap .012)	578	RW82P (Gap .012)	582	HW83F (Gap .012)	544
RTW83F (Gap .012)	645	RW83F (Gap .012)	559	W85N (Gap .013)	545	W85N (Gap .020)	203	W89D (Gap .025)	589
C95F (Gap .020)	595	W95D (Gap .040)	562	RB75N (Gap .012)	643	RGM86N (Gap .013)	586	FB77WPCC (Gap .012)	1230
XED16 (Gap .025)	563	ED14 (Gap .025)	550	XED14 (Gap .025)	572	XMD15 (Gap .025)	649	C97B (Gap .025)	513
UD16 (Gap .025)	555	RC78WYP15 (Gap .015)	1221	RC78WYP11 (Gap .011)	1218	RC78PYP (Gap .012)	1213	RB77WPCC (Gap .007)	1205
RB77WPCC (Gap .007)	1205	KB75N (Gap .012)	1219	D16 (Gap .025)	516				

DENSO To Champion

DENSO	Champion	DENSO	Champion	DENSO	Champion	DENSO	Champion	DENSO	Champion
MW22U	D9 / 509	GI31A	KB77WPCC / 229	GE31	RN79G / 642	M22	D9 / 509	M24S	D6 / 506
U20MU	Y82 / 877	GI33A	KB77WPCC / 229	MW17U	D14 / 514	W9EU	N21 / 504	M17	D14 / 514
M14	D16 / 516	L14U	D16 / 516	L14RU	RD16 / 541	GL33A	RB75WPCC / 242	GL31A	RB75WPCC / 242

Massey-Ferguson To Champion

Massey-Ferguson	Champion	Massey-Ferguson	Champion	Massey-Ferguson	Champion	Massey-Ferguson	Champion	Massey-Ferguson	Champion
834241MI	D16 / 516	834241MI	D16 / 516	834241MI	RF11YC / 22	834237MI	RF11YC / 22	834241MI	RF11YC / 22
834245MI	N5C / 120	834245MI	N5C / 120	834237MI	RF11YC / 22	834247MI	L86C / 306	834230MI	J8C / 841
834248MI	RF10C / 129	834247MI	L86C / 306	834236MI	N12YC / 38	834236MI	N12YC / 38	834234MI	L86C / 306
834234MI	L86C / 306	834232MI	J11C / 511	834230MI	J8C / 841	834225MI	J8C / 841	834225MI	J8C / 841
1060024MI	RV12YC / 406	1060024MI	RV12YC / 406	834248MI	RF10C / 129	834232MI	J11C / 511		

Motorcraft To Champion

Motorcraft	Champion	Motorcraft	Champion	Motorcraft	Champion	Motorcraft	Champion	Motorcraft	Champion
BT3	D9 / 509	BT2	D6 / 506	B4X	D9 / 509	B6W	D14 / 514	B82	D15Y / 515
B8X	D16 / 516	BR4S	XED14 / 572	BR5S	XMD15 / 649	BR7S	XMD21 / 521	BR8	RD16 / 541
BR8S	XED16 / 563	BR9S	XMD21 / 521	BS5S	XMD15 / 649	B3X	D9 / 509	BT10	D21 / 502
TT10	W14 / 569	BT4	D9 / 509	BT6	D14 / 514	BT8	D16 / 516	BT9	D21 / 502
BTS8	D16 / 516	BZ8	UD16 / 555	F11	25 / 525	TT15	W89D / 589	TT8	W14 / 569
A6S	XEJ8 / 557	BT15	D89D / 543	BS9S	XMD21 / 521	AGR8S	XEN14 / 614	TT4	W10 / 510
AER3S	RML12 / 612	AER4S	REL88B / 610	A8S	XEJ12 / 567	AER72S	XML15Y / 633	AG9	N21 / 504
B3W	D9 / 509	AGR4S	XEN14 / 614	AER3SA	XML12 / 603	AL52	H14Y / 91	AR10S	XEJ12 / 567
AR4S	XEJ8 / 557	AR5S	XMJ14 / 588	AS6S	XEJ8 / 557	B2W	D6 / 506	AGR3S	XMN12 / 616
AR6S	XEJ8 / 557	AS7S	XMJ17 / 517	AVR3S	RML12 / 612	AS5S	XMJ14 / 588	ARL8S	REL88B / 610
ARL6S	REL88B / 610	ARL4S	REL88B / 610	AR9S	XMJ20 / 573	AR8S	XEJ12 / 567	ARTS	XMJ17 / 517
AS8S	XEJ12 / 567								



CAUTION. DO NOT USE THIS CHART

UNLESS YOU ARE UNABLE TO FIND YOUR VEHICLE OR EQUIPMENT LISTED IN THE APPLICATION SECTIONS OF THIS CATALOG.

STITT To Champion

STITT	Champion	STITT	Champion	STITT	Champion	STITT	Champion	STITT	Champion
R817L	RB75N / 643	R717	RW78N / 631	R807	RM77N / 519	R80L	RB75N / 643	R817L	RB76N / 576
R847	RD15Y / 526	R847	RD16 / 541	RE72	RW83F / 559	S2SGA105	REW82P / 578	RF407L	RV12YC / 406
R717	RW77N / 565	R45	RJ88P / 644	R40L	RL15B / 535	R407XLC	RC78PYP / 218	R407L	RL15B / 535
R2SGA40L	RL85G / 1224	R107	RW80N / 553	E84	RM79F / 571	CPR887	RGM86N / 586	S2SGA40L	RHL79G / 551
CPM807	RTM77N / 547	S8MEX5	ED89D / 505	CPM80	RTM79 / 548	CPM80L	RTB80N / 646	SE722	HW83F / 544
897	D14N / 529	CPM2SGA40XL	RTN79G / 540	U827	RD16 / 541	SR827	RHM83N / 583	SR817L	RHB81N / 624
SR807	RHM77N / 596	SR7172	RHW78N / 635	SR7172	RHW77N / 577	SR1375	REW80N / 534	S8275	REM77N / 568
SR1072	RHW80N / 532	S2SGA40L5	REL88B / 610	S865	XED16 / 563	S825	XED14 / 572	S825	ED14 / 550
S47XL5MC	XEN14 / 614	S475MC	XEJ12 / 567	S40L5MC	REL89G / 522	S405MC	XEJ8 / 557	S2SGA805	REM84P / 503
S2SGA80	RHM85G / 585	S2SGA40XL	RHN79G / 575	SR137	RHW79N / 579	82	D18Y / 549	912	W89D / 589
847	M82N / 566	827	M82N / 566	727	W77N / 539	719	W18 / 518	197	W20 / 520
117	W80N / 580	107	W80N / 580	86	D23 / 523	137BSP	W16Y / 561	82	D78Y / 625
15E	25 / 525	82	D16J / 564	82	D16 / 516	82	D15Y / 515	82	D14 / 514
82	D9 / 509	82	D6 / 506	79	W18 / 518	19	C97B / 513	13	W10 / 510
10	W10 / 510	86	D21 / 502	S2SGA10	RW82P / 582	CPM10	RTW80N / 638	CPE72	RGC80F / 623
CP717	RGC77N / 552	8MEX	D89D / 543	8MEX	K97F / 597	8ME	D89D / 543	8ME	K97F / 597
817L	B86N / 542	407XL	RC9YC4 / 430	407L	RJ6C / 102	137BSP	W85N / 545	S2SGA40XL	RN79G / 530
147B	W14 / 569	17EX	C97B / 513	17EX	C95F / 595	17EX	W95D / 562	17EX	W89D / 589
17E	C95F / 595	17E	W95D / 562	17E	W89D / 589	17E	C97B / 513	15EX	25 / 525
CPM2SGA40L	RTL85G / 556	S2SGA80	RM85G / 591						

Military Shielded Resistor Types

Heat Range	Thread Size	Thread Reach	Champion	Ordnance Number	AC	Autolite (old)	Autolite (new)	Blue Crown
HOT	18 mm	1/2"	563 / XED16	---	---	BR10S	2225	SR8E13B
COLD			563 / XED16	MS35911-1	SR86E	BR8S	2225	SR8E15B
			572 / XED14	MS35911-2	SR84E	BR4S	2222	SR8E20
HOT	18 mm	1/2"	521 / XMD21*	MS51009-1	WR87	BR9S	2226	SR8E13
COLD			521 / XMD21*	MS51009-2	WR86	BR7S	2224	SR8E13
			649 / XMD15*	MS51009-3	WR84	BR5S	2223	SR8E20B
HOT	14 mm	3/8"	567 / XEJ12	MS35908-1	SR47E	AR8S, AR10S	2246	SR6F14
COLD			557 / XEJ8	---	SR46E	AR6S	2244	SR6F17
			557 / XEJ8	MS35908-2	SR44E	AR4S	2242	SR6F20C
			557 / XEJ8	7359620	SR43E	---	2242	---
HOT	14 mm	7/16"	XEH8** 557 / XEJ8	MS35909-3	SR47LE	ARL8S	2325	---
COLD			XEH8** 557 / XEJ8	8331648	SR45LE	ARL6S	2325	SR7F14
			XEH8** 557 / XEJ8	---	SR43LE	ARL4S	2325	SR7F17
HOT	14 mm	3/8"	573 / XMJ20*	MS35909-3	WR47	AR9S	2247	SR6F13
COLD			517 / XMJ17*	MS35909-2	WR46	AR7S	2245	SR6F15
			588 / XMJ14*	MS35909-1	WR44, WR43	AR5S	2243	SR6F20
			610 / REL88B	---	WR42	AER4S	2344	---
COLD			633 / XML15Y*	MS35909-6	---	AER72S	2384	---
			603 / XML12*	MS35909-4	WR44LS	AER3SA	2384	SR8F23B
			612 / RML12*	8668752	WR43L	AER3SA	2344	---
HOT	14 mm	3/4"	614 / XEN14	---	WR43LR	AGR8S	---	---
COLD			614 / XEN14	---	SR47XL	AGR4S	---	---
			616 / XMN12*	10863369	---	AGR3S	2304	---

* Requires special underwater connector.

** Discontinued plug, may use 557 / XEJ8 as a replacement

Spark Plug Installation

The recommended procedure is to remove the old spark plug and install the new spark plug by hand until it contacts the gasket seat. A new gasket should always be used. By removing and installing the spark plug by hand, it will be easier to detect any problems in the thread area such as binding or looseness. Should problems be detected, refer to the NOTE section for recommended course of action. Once all spark plugs have been installed by hand, return to the first spark plug installed and tighten to correct torque. This will allow the spark plug temperature to stabilize with the cylinder head temperatures. (Figure 1)

Torque Recommendations			
SERVICE GASKET	SPARK PLUG THREAD SIZE	TORQUE WRENCH	
		CAST IRON HEADS	ALUMINUM HEADS
	Gasket Type		
N678	14mm	26-30 lb-ft	18-22 lb-ft
A678	18mm	32-38 lb-ft	28-34 lb-ft
A478	7/8"	50-55 lb-ft	—
—	1-1/8"	140-150 lb-ft	—
	Tapered Seat		
—	14mm	7-15 lb-ft	7-15 lb-ft
—	18mm	15-20 lb-ft	15-20 lb-ft

FIGURE 1

These torque values are for spark plugs installed in clean, dry threads and should be followed unless otherwise specified by the engine manufacturer. Excessive torque (over-torque) can lead to thread body stretch.

NOTE. After the normal service life of a spark plug, one or more of the spark plugs may be a little difficult to remove. Penetrating oil may be used if the spark plug appears to be dangerously tight. Apply steady pressure with a spark plug wrench until the spark plug loosens. Once loosened, if the spark plug is still turning hard, apply more penetrating oil, then tighten and loosen the spark plug repeatedly until the spark plug rotates easily. Before removing the spark plug, blow any dirt from the port area that might be present to prevent it from falling into the combustion chamber.

If the spark plug appeared to be overly tight when removed by hand, it may be due to deposits collecting in the threaded area of the cylinder head. The threads should be cleaned with the proper size and length chaser tool, and the seat wiped clean to assure good seat contact before installing the new spark plug.

Recommended practice would be to clean spark plug port threads and seating area every six months or every spark plug change, whichever is longer.

This may lead to shell seal leakage and poor heat transfer out of the spark plug, causing premature failure. The leakage can also result in ejection of the insulator from the shell. (Figure 2)

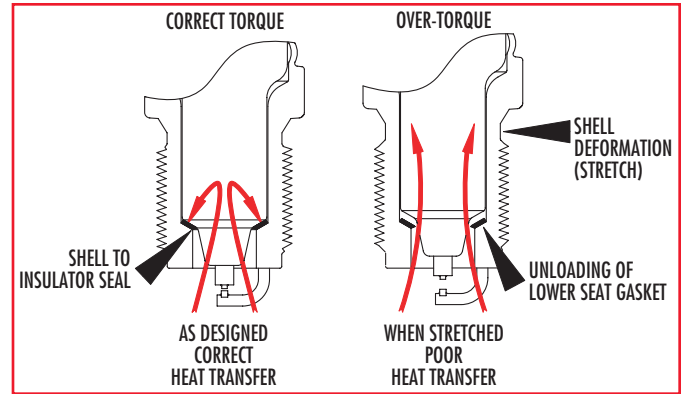

FIGURE 2

If the threads are lubricated, the torque value should be reduced 20%. Apply a very small amount only on the second thread from the firing end of the spark plug. No lubricant must be allowed on the firing end or anywhere on the upper area of the plug.

Spark plug cleanliness is essential for maximum spark plug life. All parts of the ignition system must be kept clean from dirt, oil, grease and paint. Any and all of these contaminants on the inside or outside of leads, boots and connections, or anywhere on the spark plug can cause misfire and/or shortened spark plug life.

If chasing the threads does not allow hand installation of the spark plug, further investigation is necessary. At this point it might be necessary to use a tap to verify correct thread size. Before using a tap, it is critical to verify the correct size and pitch. This tap should only be used if the thread chaser does not permit installation of the spark plug by hand. Frequent use can result in unnecessary metal removal, causing the spark plug to be loose in the port. When using the thread chaser tool or tap, a heavy grease should be applied to the flutes to catch debris removed from the thread area.

If looseness is obvious, necessary steps must be taken to avoid serious problems. A loose fitting spark plug could result in torching of the thread area and/or pre-ignition if the heat transfer from the spark plug to the cylinder head is insufficient to cool the spark plug.

Corona vs. Flashover

Under certain atmospheric conditions, a pale bluish glow may be observed around a conductor carrying high voltage. You may have noticed that while driving at night, high-tension cross-country power lines may have an eerie blue glow about them. You may also notice this glow on spark plug insulators if the engine is running in a darkened room. This glow is called corona, and it will not affect ignition output or engine performance. Corona does not indicate a faulty ignition system or spark plug.



Even if you never see corona it may leave a telltale, non-conductive, yellow or brown stain around the insulator near the top of the shell. This stain should not be interpreted as leakage between the shell and insulator. This stain is caused by the corona discharge attracting airborne dirt to the insulator surface. Corona is not to be confused with flashover, a situation where the voltage actually tracks down the outside of the insulator, resulting in misfire. Corona is harmless and is characterized by a hissing sound, much different than the familiar "snap" caused by flashover.



Flashover occurs because the high tension lead at the spark plug terminal is not adequately sealed and the voltage requirement at the spark plugs firing end is higher than the voltage requirement to arc externally.

This external arcing is flashover. Typical causes of flashover are poor or damaged ignition boots, dirty cap ends, high moisture/humidity, damaged spark plug insulators or worn firing end gaps.



Flashover is identified on the spark plug ceramic by blackened track marks where the spark has occurred externally and tracked down the surface of the insulator.

Champion provides cap end shapes to suit the needs of the application. Champion's insulator, combined with good plug boots, will prevent harmful flashover. Corona, however, can occur under any condition where high voltage is present.

Connector Well Flashover / Contamination

Shielded spark plugs have a unique set of challenges. One is contamination in the lead connector well. Contamination in this area of the plug often leads to the creation of a conductive path and eventually misfire due to flashover as seen in the quarter sectioned shielded spark plug photograph below.

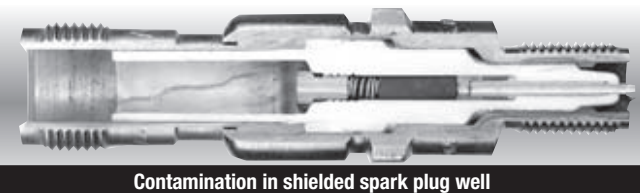

Connector well contamination may be caused by material falling into the well, faulty or loose connections, moisture or contaminated leads. The lead connection and spark plug well should be carefully inspected for contamination and condition before assembly.

The terminal lead connector (stinger) must be free of contamination internally and externally. The lead connectors are typically ceramic and are designed to last until broken. However, in some cases the inner bore of the stinger can become contaminated. This condition is difficult to detect and can result in a misfire condition. The cause of the contamination may be oil or dirt that becomes lodged between the connector lead and inner bore of the stinger. The result is the formation of a conductive path that causes the spark to arc to ground internal to the stinger with little or no evidence noticeable upon removing the ignition lead from the spark plug well.

This condition is easily detected once the stinger is removed from the ignition lead.

Inspection of the lead and bore of the stinger

may reveal arc etching of the ceramic and a corresponding mark on the ignition lead. If these marks are found the stinger/lead assembly must be replaced.



On the other hand, flashover external to the stinger whether it is from contamination, improper lead attachment or excessive voltages due to a worn out spark plug is often more easily identifiable as can be seen on the stinger in the photograph above. When arcing is found on the outside of the stinger, there is a good chance that the spark plug well also has been etched by the arc. If this is the case, both the stinger and the spark plug need to be replaced.

As greater demands are applied at the spark gap, the required voltage increases. This increased voltage will follow the path of least resistance. Contamination in the spark plug well or stinger assembly will contribute to the creation of alternate paths. Often-times replacement of the spark plug will eliminate the misfire. In the case of a contaminated well it will solve the problem. In the case of a contaminated stinger assembly a new plug with a tight gap and sharp edges will reduce the voltage requirement and provide a temporary solution. If plug life appears to steadily decrease the stinger assembly should be carefully inspected for contamination.

The Spark Plug's Relation to the Ignition System

The ignition system must be capable of supplying the voltage necessary to initiate a spark between the spark plug electrodes. In practice this means there must be considerable "ignition reserve" to compensate for normal wear of the spark plugs and components of the ignition system.

Ignition reserve is the difference between voltage available (V_a) from the ignition system, and voltage required (V_r) by the spark plug. If at any time V_r equals V_a , misfire will likely occur. (Figure 3)

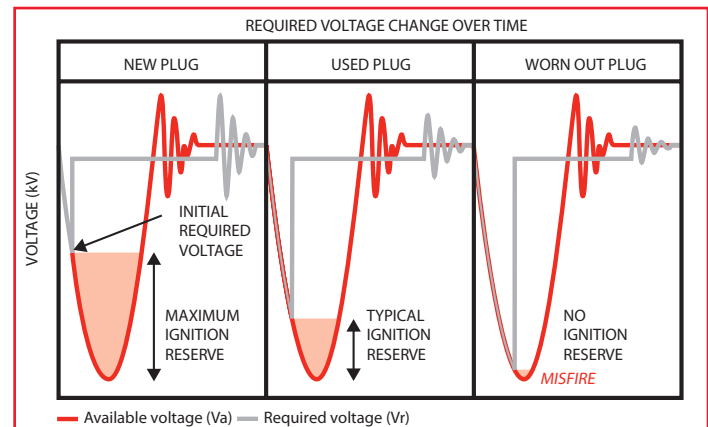

FIGURE 3

Factors Affecting Voltage Requirements (V_r)

COMPRESSION PRESSURE

Depending on the type of fuel, moisture content and voltage source, required voltage increases as pressures increase.

IGNITION TIMING

At TDC (top dead center), voltage requirements will be greatest due to high compression pressures. An advance in timing lowers V_r as pressure decreases. Since the advance creates higher flame temperature, V_r is further reduced by the hotter electrodes. Retarding timing past TDC also decreases V_r as pressures decrease, but appreciable losses of power and temperature result.

SPEED AND LOAD

High speed and load generally produces the highest V_r due to increased cylinder pressures despite the natural increase in electrode temperatures.

ELECTRODE TEMPERATURE

Voltage requirements will decrease as electrode temperatures increase and increase as temperatures decrease.

ELECTRODE CONDITION

Sharp, new electrodes concentrate the spark arcing by offering an easier path for current flow. As new plugs with well-defined electrodes wear, an increase in required voltage results.

ELECTRODE MATERIAL

Commonly used electrode materials are platinum, iridium, gold-palladium and nickel, in descending voltage equipment.

GAP SIZE

With other influencing factors being equal, required voltages will increase as gap size increases.

Multi-strike ignition: While multi-strike ignition can be beneficial for igniting the air-fuel charge, particularly in lean burn applications, it also accelerates gap wear. To minimize wear, use the fewest number of ignition strikes necessary to achieve complete combustion.

COIL POLARITY

Polarity is a design feature of each ignition system. Current flow from center electrode to ground electrode is referred to as "negative polarity." "Positive Polarity" is current flow from the ground electrode to center electrode. Most all manufacturers recommend negative polarity for best spark plug life and performance, since reversed or positive polarity will increase required voltages and substantially reduce ignition system reserve.

FUEL/AIR RATIO

With other factors being equal, voltage requirements will be lowest at the ideal stoichiometric fuel/air ratio. Voltage requirements increase with leaner mixtures because air is a poor conductor.

TURBOCHARGING

Turbo charging increases the voltage requirement because of higher cylinder pressures.



Factors Affecting Voltage Requirements (Vr) Continued

LOW VOLTAGE	LOW	COMPRESSION PRESSURE	HIGH	HIGH VOLTAGE
	ADVANCE AWAY FROM TDC	IGNITION TIMING	RETARD TOWARDS TDC	
	LOW	SPEED AND LOAD	HIGH	
	HOT	ELECTRODE TEMPERATURE	COLD	
	WELL DEFINED	ELECTRODE CONDITION	WORN	
	NICKEL	ELECTRODE MATERIAL	PLATINUM	
	NARROW	GAP SIZE	WIDE	
	NEGATIVE	COIL POLARITY	POSITIVE	
	STOICHIOMETRIC	FUEL/AIR RATIO	LEAN	
	LOW	TURBOCHARGING	HIGH	

FIGURE 4

Factors Affecting Spark Plug Temperatures

SPEED AND LOAD

As engine power requirements increase with speed and load, spark plug insulator temperatures increase proportionately. Temperatures at constant speed and load will remain relatively stable.

IGNITION TIMING

Ignition timing has one of the greatest effects on insulator temperature. Advances in timing subjects the insulator, as well as all other parts of the combustion chamber, to longer periods of flame exposure. Recommended spark plug heat ranges, therefore, must consider manufacturer's specified timing and fuel/air ratios. Any advances over specifications will increase insulator temperatures.

CYLINDER HEAD TEMPERATURES

Insulator temperatures will vary almost directly with cylinder head temperatures. A fifty degree increase in coolant temperature will increase the insulator temperature approximately fifty degrees-a negligible amount. In cases of localized cooling system blockages (liquid or air), it is possible to create severe overheating.

Extremes in ambient operating temperatures can be detrimental to cylinder head temperatures by creating a detonation or pre-ignition environment.

DETONATION

Detonation produces severe pressures and temperatures which may affect not only spark plug temperatures but also may impose severe stress on insulators, electrodes, pistons, valves, bearings and other engine components.

PRE-IGNITION

Pre-ignition will generally cause a very rapid and severe temperature rise in the spark plugs and other combustion chamber components.

INSTALLATION TORQUE

Over-torquing or under-torquing upon installation can impair heat transfer out of the spark plug, causing the spark plug to leak and run hotter, decreasing its life.

COLD	LOW	ENGINE SPEED	HIGH	HOT
	LOW	ENGINE LOAD	HIGH	
	RETARDED	IGNITION TIMING	ADVANCED	
	LOW	CYLINDER HEAD & COOLANT TEMPERATURE	HIGH	
	NONE	DETONATION	SEVERE	
	NONE	PRE-IGNITION	SEVERE	
	CORRECT TORQUE	INSTALLATION TORQUE	OVER/UNDER-TORQUE	

FIGURE 5

Heat Range Facts

The term “Heat range” refers to a spark plug’s thermal characteristics: more specifically, to its ability to dissipate combustion heat from its firing end to the cylinder head and cooling medium.

A spark plug must maintain an even flow of heat from its firing end to avoid becoming a source of re-ignition. Yet it also must operate hot enough to burn off conductive deposits that can short-circuit the high voltage and result in misfire.

For any specific application, it is the range of temperatures from low speed and low load to high speed and heavy load that determines the heat range requirement of a spark plug. From a design standpoint, the range of operating temperatures is largely determined by the length of the insulator nose. The longer the insulator nose, the hotter the spark plug. (Figure 6)

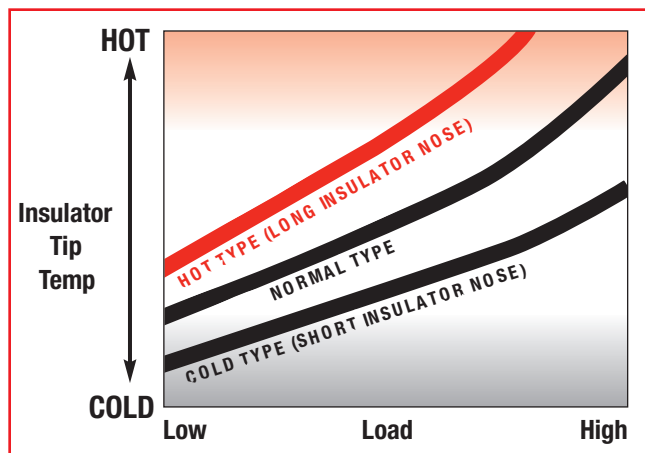

FIGURE 6

Thermocouple plugs designed by Champion are used to monitor firing tip temperatures. For best service at all load conditions, the optimum range of temperatures a plug should operate within is between 700°F and 1200°F (400°C to 650°C). The final selection of a plug for an engine is made on this basis.

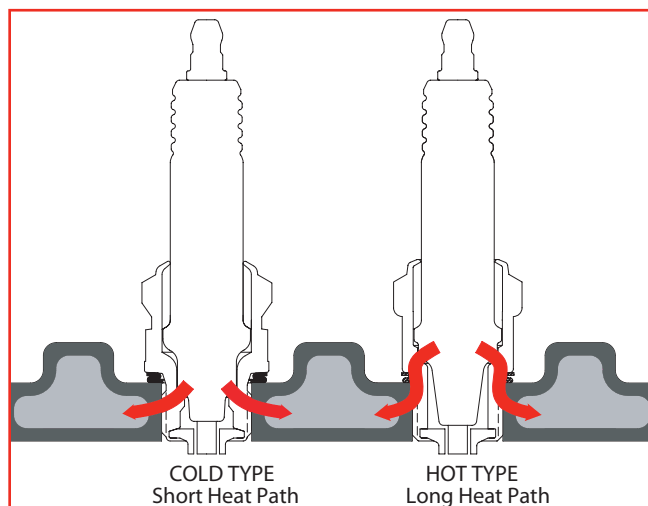

FIGURE 7

Usually each size and design of a spark plug is manufactured in various heat ranges as illustrated. They vary from a “colder” type, which operates on the lower end of the temperature scale, to a “hotter” type, which operates on the higher end of the same scale in the same engine under identical conditions.

Spark plugs with short insulator firing tips are called “cold” designs because they dissipate heat rapidly. They vary from a “colder” type, which operates on the higher end of the temperature scale, to a “hotter” type, which operates on the higher end of the same scale in the same engine under identical conditions. (figure 7)

It is the temperature at which the plug operates that determines whether it is a hot or cold type, and not necessarily the design.

TYPES OF GROUND ELECTRODE

There are several ground electrode configurations. Those that project furthest from the spark plug into the combustion chamber will have the longest heat transfer path. Four-prong ground electrodes run colder than J-gap ground electrodes due to the shorter heat transfer path. However ground electrode projection may be beneficial for certain applications. (Figure 8)

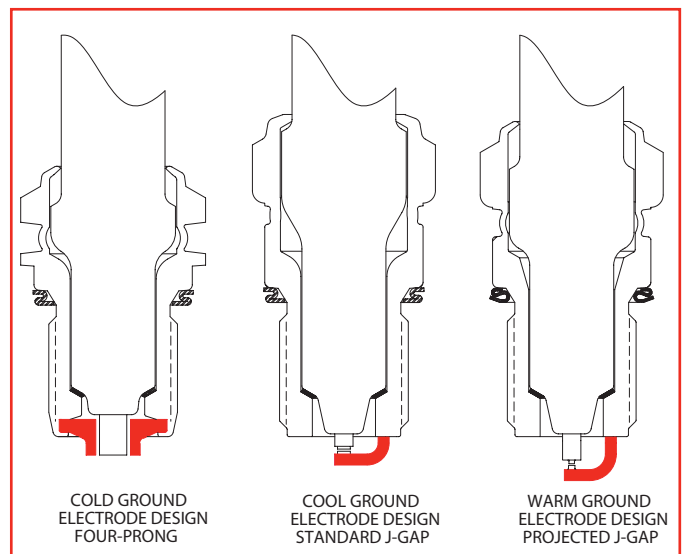

FIGURE 8

COPPER CORED ELECTRODES

The use of copper cored electrodes improves heat transfer, resulting in longer gap life. Copper is used in most center electrodes and in J-gap ground electrodes.

SEAT GASKET TEMPERATURE

Seat gasket thermocouple spark plugs can be used as an indicator of heat transfer out of the spark plug. Spark plug seat gaskets are intended to run no hotter than 400°F. If a seat gasket thermocouple reads above this, spark plugs and engine performance may be adversely affected.



Effect of Fuel on Spark Plug Selection

While most engines are designed for a specific fuel and placed into service with specifications tailored to that fuel, some operators are making conversion to different fuels or multi-fuel operation.

Spark plug selection of heat range and gap spacing should follow manufacturers' guidelines. When converting to alternative fuels see the spark plug selection chart. (figure 9)

FUEL TYPE	APPROX. OPTIMUM ENGINE COMP. RATIO	AVERAGE OCTANE RES. NO.	MANIFOLD HEAT REQUIRED	SPARK PLUG HEAT RANGE	SPARK PLUG GAP SPACING	IGNITION VOLTAGE REQUIRED
Natural Gas (methane)	14:1 (plus)	115-120	DECREASE	COLD	CLOSE	HIGH
LP-Gas	9:1 - 12:1	95-105	↑ ↓	↑ ↓	↑ ↓	↑ ↓
Gasoline	8:1 - 11:1	85-100				
Kerosene	5:1 - 7:1	35-50	↑ ↓	↑ ↓	↑ ↓	↑ ↓
Distillate	4:1	25-30				
			INCREASE	HOT	OPEN	LOW

FIGURE 9

Low energy fuels often contain contaminants which can decrease spark plug life due to deposit build-up. (Figure 10)

LOW ENERGY	FUEL SOURCE	TYPICAL COMPOSITION
Landfill gas	Natural anaerobic decomposition of organic landfill waste.	55% methane and 45% CO ₂ with small amounts of oxygen and nitrogen, and contaminants such as sulfur compounds, halides, acids and solids.
Digester gas	Natural anaerobic decomposition of organic waste from sewage, animal waste or waste from vegetable and alcohol mills.	65% methane and 35% CO ₂ with small amounts of oxygen and nitrogen, and contaminants as above.
Blended fuel	Landfill or digester gas enriched with natural gas.	Depends on fuel concentration.

FIGURE 10

Shielded Extensions, Non-Shielded Extensions, Gaskets and Terminal Nut

Spark Plug Shielded Extensions



EXTENSIONS		
5/8"-20 THREAD		
LENGTH	PART#	REORDER#
4"	SE-4B	92966
6"	SE-6B	94462
8"	SE-8B	92821
10"	SE-10B	11500

3/4"-20 THREAD		
LENGTH	PART#	REORDER#
4"	SE-4D	11496
6"	SE-6D	93538
8"	SE-8D	93717
10"	SE-10D	11503



TEFLON IGNITION RODS		
LENGTH	PART#	REORDER#
4"	SE-4T	11497
6"	SE-6T	11504
8"	SE-8T	11505
10"	SE-10T	11506



TERMINAL NUT		
LENGTH	PART#	REORDER#
	BN9A	11276



GASKETS		
LENGTH	PART#	REORDER#
14MM	N678	91954
18MM	A678	91591
7/8MM	A478	94349

Spark Plug Non-Shielded Extensions



TEFLON DIELECTRIC SHIELDS		
LENGTH	PART#	REORDER#
3"	DS3	13601
4"	DS4	13602
5"	DS5	13604
6"	DS6	13607
8"	DS8	13609
10"	DS10	13610
12"	DS12	13611
14"	DS14	13612
16"	DS16	13613
18"	DS18	13614
20"	DS20	13615
24"	DS24	13617

#50KV RESISTANCE



ALUMINUM EXTENSION RODS			
LENGTH	PART#	REORDER#	
3"	SCE3	13587	
4"	SCE4	13588	
5"	SCE5	13589	
6"	SCE6	13590	
8"	SCE8	13591	
10"	SCE10	13592	
12"	SCE12	13594	
14"	SCE14	13595	
16"	SCE16	13596	
18"	SCE18	13597	
20"	SCE20	13599	
24"	SCE 24	13600	

#8-32 INTERNAL THREAD

Integral Coil Features



Integral coils must be installed at a maximum of 5 lb-ft after the spark plug has been installed to follow coil manufacturer instructions for tightening. Over-torque can cause damage to coil and/or plug, resulting in possible engine damage. The "T" type and "G" type spark plugs

described below are designed to be used in conjunction with ignition systems utilizing an integral (transformer) coil. These plugs along with the use of integral coils have been approved by Canadian Standards Association for Class 1, Group D, Division 2 hazardous-location service.



"T" TYPE SPARK PLUGS

A "T" type spark plug is shown in Figure 11. Typical plugs are the RTM82WPCC, RTM77N, RTM78N, RTB78N, RTB80N, RTL85G, RTN79G, TJ83, RTW80N and RTW83F. These coils require that the shell turnover has a 13/16" thread to accommodate the female threaded coil.

FIGURE 11



"G" TYPE SPARK PLUG

A "G" type spark plug is shown in Figure 12. Typical plugs are the RGC80N, RGC80F and RGC77N in the 7/8" line and the RGM86N in the 18mm line. These utilize a 1" upper female threaded shell.

FIGURE 12



Shielded Extension Features and Installation

Typical Shielded Spark Plug

Shielded Extension

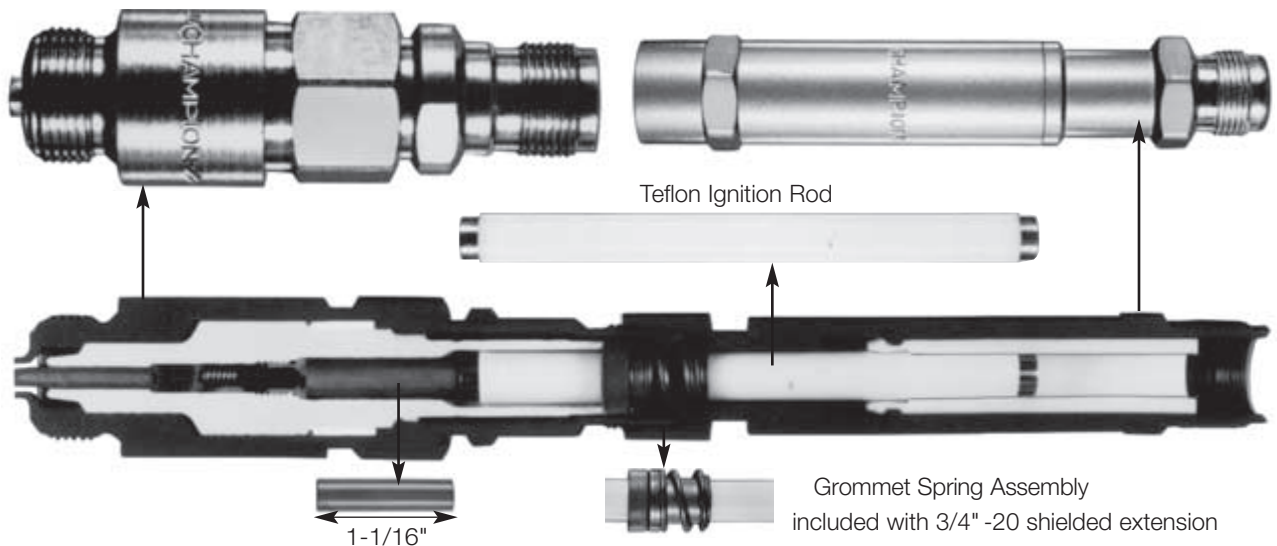

NOTE: This extension assembly can only be used with spark plug with a 1" well depth such as RHL79G, RHL89G, RHN79G, RHM77N, RHM83N, RHM85G, RHW79N, RHB81N. The following have a 2" well and require a brass rod adapter: RHM78PP, RHM78WPCC, RHW77N, RHW78N, RHW80N, HW83F.

- Install spark plug and tighten to recommended torque.
- Take center rod and install spring assembly and rubber grommet with at least 1-1/2" of center rod extending from bottom.
- Insert center rod with spring assembly and grommet into shielded spark plug.

- Install shielded extension over the center rod pushing the grommet and spring assembly down to the shell. This will ensure the center rod is in contact with the terminal of the spark plug.
- Tighten shielded extension to a maximum of 5 lb-ft.



An effective way to diagnose an engine's operating conditions is to examine the used spark plugs for abnormal conditions. If all systems of a given cylinder are in proper working condition, the recommended spark plug will take on deposit, gap wear and insulator coloring characteristics which must be considered normal. By indexing each plug to its respective cylinder and location during removal, the technician can later scrutinize the

plug under magnification to determine the possibility of engine abnormalities.

This procedure can be very useful if conducted as part of regular maintenance inspections. The following series of photographs and explanations may serve as a guide to spark plug and engine analysis; conditions will vary from engine to engine.

NORMAL

Appearance. Slight even wear on electrodes, very light deposits, a coloring of brown or grayish tan. Very clean, deposit-free firing ends are common on LP and natural gas applications.

Indication. Correct spark plug for application; cylinder from which removed is "healthy."

WORN OUT

Appearance. Very pronounced wear on electrodes, widened gap space.

Indication. Worn condition creates high voltage requirement and stresses the ignition system. Replace with equivalent heat range, perform routine ignition maintenance.

BRIGED GAP

Appearance. A deposit lodged between the electrodes which "short-circuits" the ignition voltage.

Indication. Flaking off of combustion chamber deposits. May happen after long periods of constant speed and load operation followed by cyclic accelerations.

OIL ASH DEPOSITS

Appearance. Light colored (generally grayish) crusty build-up on spark plug firing end. May vary in density from very soft and flaky to extremely hard and rock-like.

Indication. Residual deposits from oil entering the combustion chamber in small amounts and being burned. These deposits, depending on oil additives, may be non-conductive and harmless. However, sufficient quantities of these deposits may build to mask the entire firing end and affect initiation of combustion. Should the deposits be conductive, the potential is great for core nose tracking and misfire.

LANDFILL GAS DEPOSITS

Appearance. Light colored (generally white) crusty build-up on spark plug firing end. May vary in density from very soft and flaky to extremely hard and rock-like.

Indication. Residual deposit from an engine operated on gas from a landfill. This type of fuel is often referred to as "dirty" gas, thus the naturally occurring deposits. These deposits may be non-conductive and harmless, but sufficient quantities may build to mask the entire firing end and interfere with the initiation of combustion. Should the deposits be conductive, the potential is great for core nose tracking and misfire.

DETONATION

Appearance. Electrodes or insulator fractured/physically broken as if by mechanical means.

Indication. Engine operated under abnormal combustion-detonation (uncontrolled burning or exploding of the fuel/air charge). Generally due to excessive temperature from over-heating, improper fuel/air ratios, over-advanced timing, cooling system blockages, insufficient engine tolerances, or improper balance of fuel mixture and timing.

PRE-IGNITION

Appearance. Overheated spark plug with electrodes and/or insulator melted.

Indication. Engine operated under abnormal combustion-pre-ignition (ignition prior to timed spark). Pre-ignition generally results from excessive temperatures created by "hot spots," possibly carbon, sharp valve edge, gasket protruding into the chamber, or improper heat range plug.

CORE NOSE TRACKING

Appearance. Ignition marks etched into the insulator core nose, or its deposits, that travel from the center electrode up the core nose to ground within the shell bore. These marks are often black in color.

Indication. Misfire may occur as the ignition spark has found an alternate path to ground as opposed to the desired path of arcing from center electrode to the ground electrode. Tracking can be caused by any of the following conditions: Conductive deposits on the insulator core nose, too wide a spark gap, too lean a fuel/air ratio, increased cylinder pressures at time of ignition.

CARBON FOULED

Appearance. Soft, black sooty deposits covering firing end.

Indication. Possible problem in the fuel delivery system – overly rich. Weak ignition system, flashover or secondary voltage, leak, or extremely low compression. More common to gasoline fueled auxiliary type engines.

TORCHED SEAT

Appearance. Cutting torch effect in the thread and seat area of the plug shell.

Indication. Plug was not seated properly, could not dissipate heat and allowed gases to blow by the threaded area.

Normal



Usure normale
Normal

Detonation



Détonation
Detonación

Worn Out



Usure totale
Desgastada

Pre-ignition



Préallumage
Encendido prematuro

Bridged Gap



Écartement obstrué
No existe separación entre puntas

Core Nose Tracking



Traces de cheminement de l'isolant
Formación de trayectorias en la nariz

Oil Ash Deposits



Dépôts résiduels d'huile
Depósitos de cenizas aceitosas

Landfill Gas Deposits



Dépôts résiduels de gas d'enfouissement
Depósitos de gas de vertedero

Carbon Fouled



Calaminage
Cubiertas de carbón

Torched Seat



Siège brûlé
Asiento quemado

Find the latest Champion Industrial Information at:

